



DATA SOUND - LABORATORIES -

EMBEDDING THE FUTURE



**Electronic
Design**



**Panel
PC / HMI**

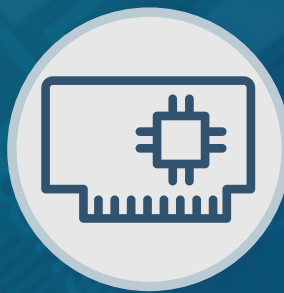

**Single Board
Computer**



**Industrial
PC**

Why choose DSL?

- Over 25 Years Industry Experience
- 5 Years Warranty on all Products
- Evaluation Products Available
- Lifetime Technical Support

Our Services

- Electronic Design
- Production Management
- Assembly and Test
- Bespoke BIOS Creation
- Industrial Embedded PC Solutions



Call us on +44(0)1462 675530



Email us at sales@dsl-ltd.co.uk



www.dsl-ltd.co.uk

EBOX-ALN3350/ ALJ3455

User's Guide



Copyright

The information in this manual is subject to change without notice for continuous improvement in the product. All rights are reserved. The manufacturer assumes no responsibility for any inaccuracies that may contain in this document, and makes no commitment to update or to keep current information contain in this manual.

No part of this manual may be reproduced, copied, translated or transmitted, in whole or in part, in any form or by any means without the prior written permission of the DMP Electronics Inc.

©Copyright 2019 DMP Electronics Inc.

Trademarks Acknowledgment

Intel® Apollo Lake is the registered trademark of Intel Corporation.



is the registered trademarks of DMP Electronics Inc.

Other brand names, product names or trade names appearing in this document are the properties and registered trademarks of their respective owners. All names mentioned herewith are served for identification purpose only.

Safety Information

WARNING

- Do not expose EBOX to rain or moisture, in order to prevent shock and fire hazard.
- Never install EBOX in wet locations.
- Do not open cabinet to avoid electrical shock. Refer to the nearest dealer for qualified personnel servicing.
- Never touch un-insulated terminals or wire unless power adaptor and display monitor are disconnected.
- Locate EBOX as close as possible to the socket outline for easy access and to avoid force caused by entangling of your arms with surrounding cables from the EBOX.
- When using EBOX, avoid using or installing the modem to the serial port during a storm or a lightning.
- Do not use the modem or a telephone to report a gas leak in the vicinity of the leak.
- USB connectors are supplied with Limited Power Sources.

**DO NOT ATTEMPT TO OPEN OR TO DISASSEMBLE THE CHASSIS (ENCASING)
OF THIS PRODUCT. PLEASE CONTACT YOUR NEAREST DEALER FOR
SERVICING FROM QUALIFIED TECHNICIAN.**

Regulatory

FCC Class A Note

This equipment has been tested and found to comply with the limits for a Class A digital device, pursuant to Part 15 of the FCC Rules. These limits are designed to provide reasonable protection against harmful interference when the equipment is operated in a commercial environment. This equipment generates, uses and can radiate radio frequency energy and, if not installed and used in accordance with the instruction manual, may cause harmful interference in which case the user will be required to correct the interference at his own expense. Testing was done with shielded cables. Therefore, in order to comply with the FCC regulations, you must use shielded cables with your installation.

WARNING

This product complies with EN55022 class A. In a domestic environment this product may cause radio interference in which case the user may be required to take adequate measures.

Changes or modifications to this unit not expressly approved by the party responsible for compliance could void the user's authority to operate the equipment.

This device complies with Part 15 of the FCC rules. Operation is subject to the following two conditions: (1) this device may not cause harmful interference, and (2) this device must accept any interference received, including interference that may cause undesired operation.

This digital apparatus does not exceed the Class A limits for radio noise emissions from digital apparatus as set out in the interference - causing equipment standard entitled "Digital Apparatus", ICES-003 of the Department of Communications.

Manufacturer's Declaration of Conformity

This equipment has been tested and found to comply with the requirements of European Community Council Directives 89/336/EEC & 73/23/EEC relating to electromagnetic compatibility and product safety respectively.

Attention

This product has been designed and certified to comply with certain regulatory requirements pertaining to Information Technology Equipment. This product has not been designed for use as a medical device. Without limitation of the foregoing, this product is not intended and has not been certified for use in a hospital or clinical environment to diagnose, treat, or monitor patients under medical supervision, and is not intended and has not been certified to make physical or electrical contact with patients, nor to transfer energy to or from patients and/or to detect such energy transfer to or from patients.

Purchase Agreement

Purpose:

In accordance to the general commercial conduct of Trust and Fair Trade, herewith below is the agreement for the protection for both parties, DMP and Users in pursuant of trading.

Product Description:

With this product, herewith known as EBOX-ALN3350/ ALJ3455 which is a simplified & an economical design of an embedded device for Special Purpose Personal Computing. The basic specification of this product is comprised of Intel® Apollo Lake N3350 or J3455 processor, 4GB SO-DIMM DDR3L memory, HDMI, VGA output, four USB3.0 ports, RS-232, RS-485, RS-422 3-in-1 Serial port and two 1G LAN Interfaces.

Distribution Convention:

1. This Product includes a PC and a power supply unit. Upon receiving this product, please refer to user manual to check for the contents and appearance of this product; contact the nearest dealer or DMP office for any defective or missing parts immediately. The supplier will not be responsible for any reported discrepancy there after the expiration period of 3-days from the received date.
2. In consideration of transportation and the cost of storage, the supplier provides to the distributors a warranty of 12 months. This warranty covers the failure caused by hardware breakdown (excluding hard drives), but does not cover the act of misuse and mishandling.
3. The supplier will not accept unknown post, therefore if you wish to repair or to return your goods – kindly please contact your nearest dealer to make your declaration, and at the same time, apply for an RMA number (RMA stands for Return Merchandise Authorization – please ask for RMA form and fill-up for authorization).
4. The freight for return goods for repair will follow the International customary practice and convention: Both parties is to pay for freight of one shipment each. The shipper is required to prepay the freight from the place of origin (This means that the returnee (user) covers the freight for return goods, while the Supplier covers the freight for goods after the repair).
5. Obsolete warranty is referred to as: (1) Expiration of warranty or (2) Damage due to misuse within warranty. The Supplier will be taken into consideration of the circumstances, to provide repair service with charges expense for obsolete warranty. This expense includes the cost of material and the cost of labor.

Note: If there is other particular issue, not listed in the above conditions, both parties agreed to follow the General Law of Commerce with fair and reasonable discussion in handling and resolving the argument.

Contents

Chapter 1

- 07 Unpacking EBOX Mini PC

Chapter 2

- 10 Overview
- 11 Internal description
- 12 Appearance Diagram
- 13 System Specifications
- 14 Peripherals

Chapter 3

- 17 BIOS Reconfiguring
- 17 Load Default Setting
- 18 COM Setting (RS-232/485/422)
- 20 AT Mode Setting (Auto Power On Function)
- 21 Serial Port Console Redirection
- 21 OS Selection
- 23 PXE diskless boot Selection
- 24 Drivers Installation Guide
- 24 Chipset driver
- 25 Graphic driver
- 26 Audio driver
- 27 LAN driver
- 28 TXE driver
- 29 iRMT driver
- 30 ISH driver

Chapter 4

- 32 Onboard Connectors Summary
- 33 Pin Assignments

Chapter 5

- 38 Taking Care of EBOX
- 40 Troubleshooting

Chapter 6

- 43 Terms and Condition
- 43 Warranty
- 43 Service and Support
- 43 Return Merchandise Authorization (RMA) Policy
- 43 Shipping Policy

Chapter 1

Unpacking EBOX Mini PC

Component List:

Item No.	Description	Quantity
1	EBOX-ALN3350/ ALJ3455 Mini PC	x1
2	40W Power Adaptor, Vin: 100~240V AC 50~60Hz	x1
3	Power cable (available US, UK, EU, AU types)	x1
4	VESA screw	x4

Note: The accessories are subject to change without immediate notice.

Check before Use



Preface

EBOX-ALN3350/ ALJ3455 Mini PC



EBOX-ALN3350/ ALJ3455 is powered by Intel® Apollo Lake N3350/ J3455 processor, and 4GB SO-DIMM DDR3L module that handles processing efficiently and provides fast performance. It is a revolutionary device designed for limited physical space and temperature concerns. No matter you are in a jammed office, a crowded place, or public transportation, EBOX can be easily integrated with VESA monitor to access at any time.

EBOX can be attached to any VESA mounting fixture; allowing it to be securely mounted onto desks, walls, or buildings, and thereby optimizes your work area. It can also attach directly to any size LCD for a mobile system for the use at trade shows, presentations, promotions, etc. With FANLESS design, it's ideal to be used in the environment where temperature demand is critical.

OS such as Windows 10, Windows 10 IoT and Linux can be installed to meet ready-to-market demand and provide competitive advantages for customers.

Chapter 2

EBOX-ALN3350/ ALJ3455 Overview

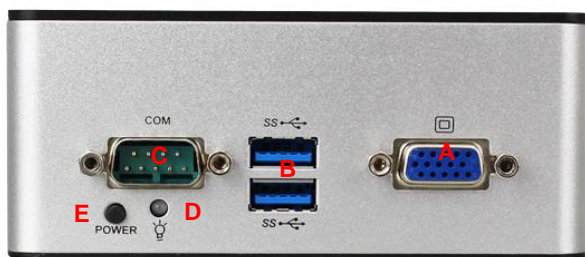

Front Panel

A: VGA port

Support VGA display

B: USB 3.0 port

Connection for external USB devices

C: COM port (RS-232/485/422)

Connection for serial port

D: Power LED

LED lights up when the system is turned on

E: Power Button

For system power on/off

Note: The COM port can function as RS-232/485/422 port. Change default setting RS-232 to RS-485 or RS-422 in BIOS menu before using. Instruction refer page 17, 18.

Back Panel

F: USB 3.0 port

Connection for external USB devices

G: RJ-45 LAN Jack

Realtek 8111H GigaLAN

H: HDMI Output port

Support HDMI display

I: Mic in/Line out phone jack

Realtek ALC662VD Mic in/Line out combo jack

J: Power Jack

Volt: DC 12V input only



Internal description

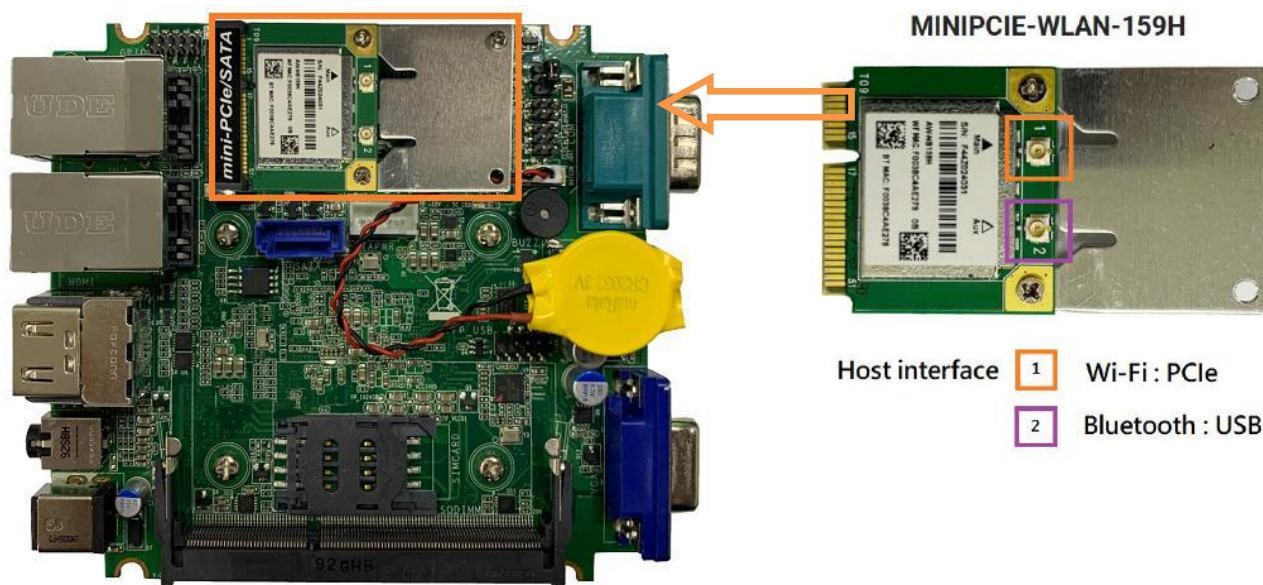
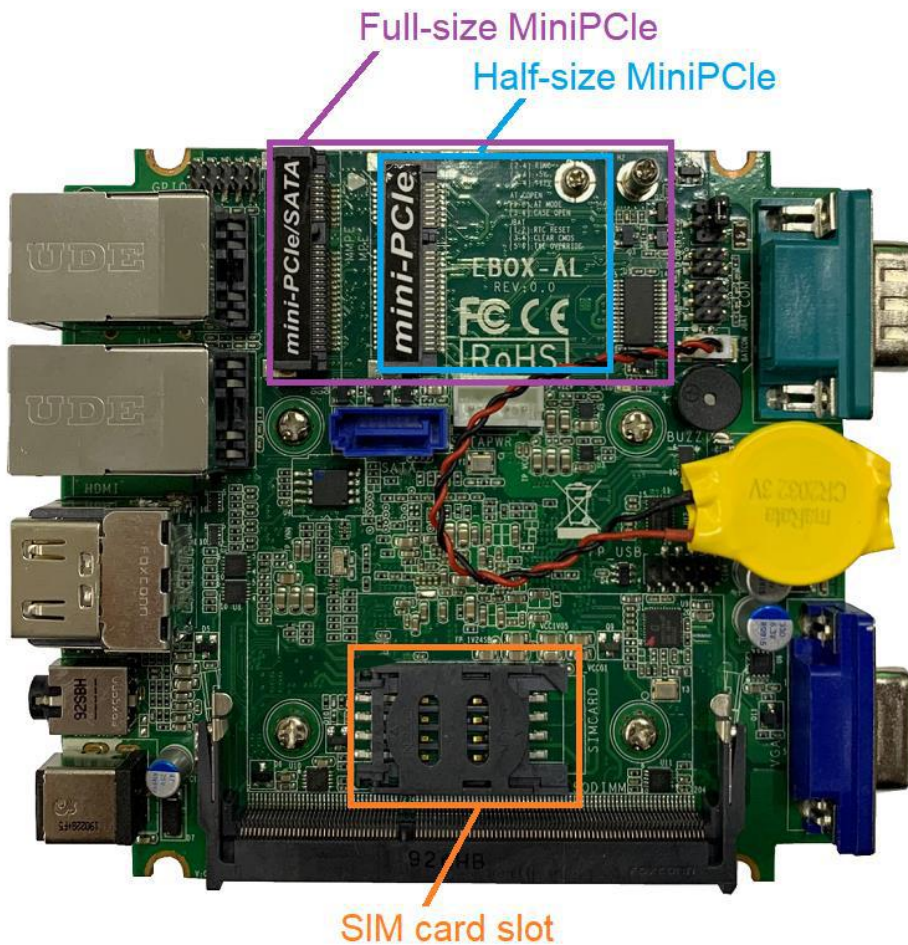

Optional item MINIPCIE-WLAN-159H Wi-Fi/BT module info www.compactpc.com.tw

Appearance Diagram

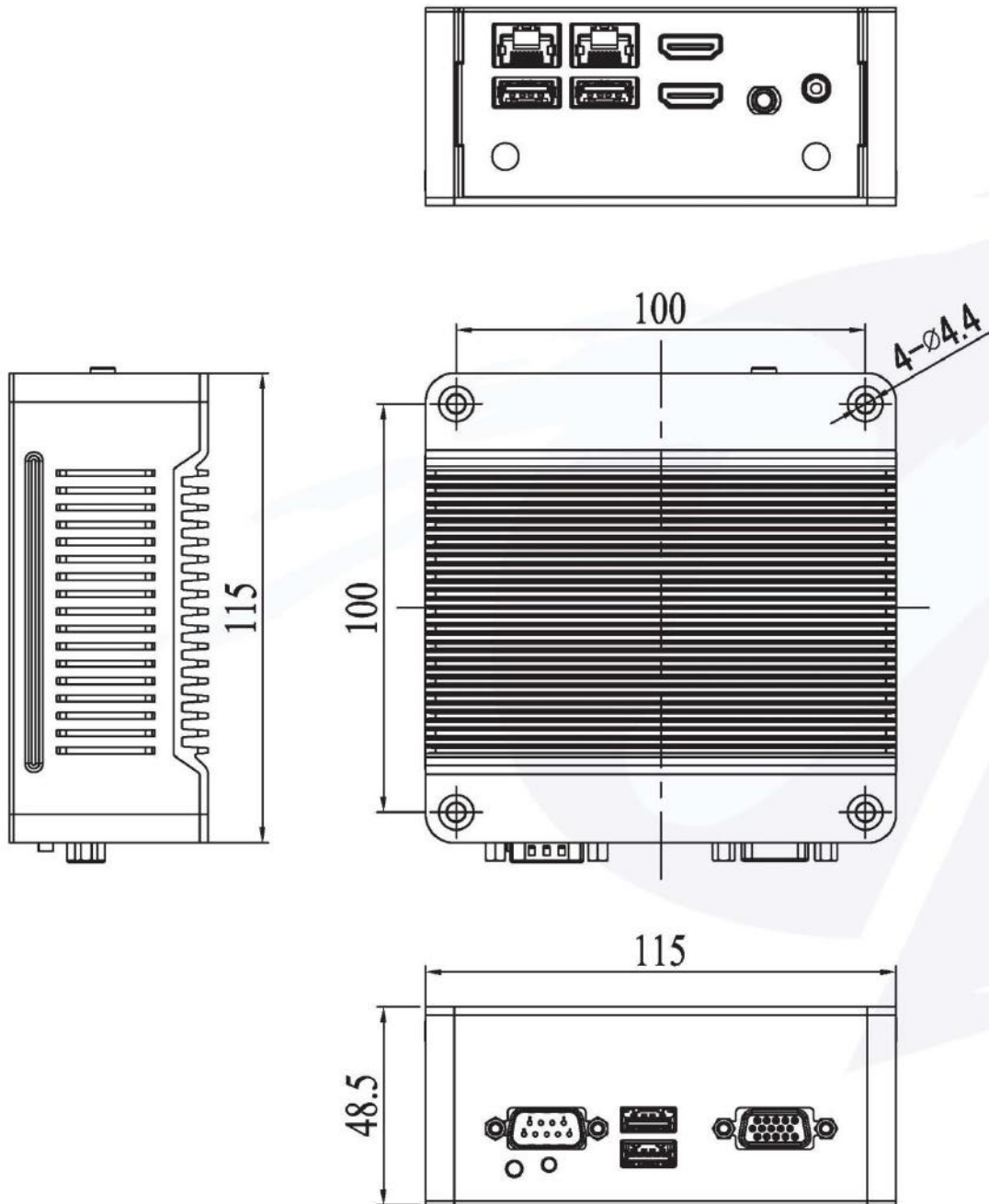

Specifications

CPU	Intel® Apollo Lake N3350 Dual Core 1.10GHz, 2.40GHz (Burst) 6W Intel® Apollo Lake J3455 Quad Core 1.50GHz, 2.30GHz (Burst) 10W	
RAM	DDR3L 1866MHz memory support up to 8GB in SO-DIMM slot x1	
BIOS	AMI BIOS	
Expansion	Full-size MiniPCle x1 (co-lay mSATA for Storage)	
	Half-size MiniPCle x1	
	SIM card slot (Function via Full-size MiniPCle)	
Display	Intel® HD Graphics with MultiDisplay support	
	HDMI : Maximum resolution support up to 3840 x 2160 @30Hz	
	VGA : Maximum resolution support up to 1920 x 1200 @60Hz	
Audio	Realtek ALC662VD	
LAN	Realtek 8111H GigaLAN x2 (Built-in PXE diskless boot)	
Disk Support	mSATA x1	SATA device x1
Internal I/O	4-pin wafer for SATA power output x1	SIM card holder x1
	5-pin header for SMBus x1	MiniPCle slot / mSATA x1
	USB 2.0 x2 (pin type)	Half-size MiniPCle slot x1
External I/O	HDMI V1.4 x2	USB 3.0 x4
	15-pin D-sub connector for VGA x1	RJ45 connector for GigaLAN x2
	9-pin D-sub connector for COM x1 (RS-232/485/422)	Phone Jack for Line-out / MIC-in x1
Power Requirement	DC +12V standard input from power jack	
Operating Temperature	0°C to 60°C (with Airflow)/ -10°C Bootable	
Dimension	115 x 115 x 48.5mm	
Mounting	VESA 100 x 100mm	
Net Weight	660g	
Certifications	CE, CF, VCCI	
OS Support	Windows 10, Windows 10 IoT, Linux	

Peripherals

Connecting the Power Adaptor



A: DC power Jack

+12V@3.33A AC adapter with power cable is used for the power source

Connecting the Monitor



B: VGA Connection

Connecting VGA display via VGA cable



C: HDMI Connection

Connect HDMI display via HDMI cable

Peripherals

Connecting Input & Output ports

EBOX-ALN3350/ ALJ3455 provide 4 external USB ports (2 at front, 2 at rear).

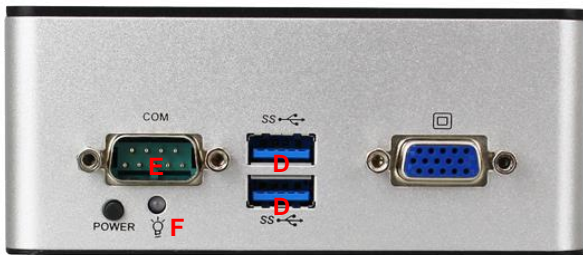

D: USB 3.0 port

Connection for external USB devices, supports up to 5Gbps data transfer rate

E: Serial port (RS-232/485/422)

Connection for serial port interface devices

F: Power LED

Power LED lights up when the system turned on



G: RJ-45 LAN

RJ-45 LAN jack for Ethernet connection

H: Microphone/ Earphone

This connector can functions as audio Line out and Mic in jack with compatible cables and devices

Chapter 3

BIOS Reconfiguring

Load Default Setting

1. AMI BIOS is used in EBOX; To reconfigure the hardware, press or <Esc> key to enter BIOS setup main menu.
2. Press “F3” key to load optimized defaults as below:

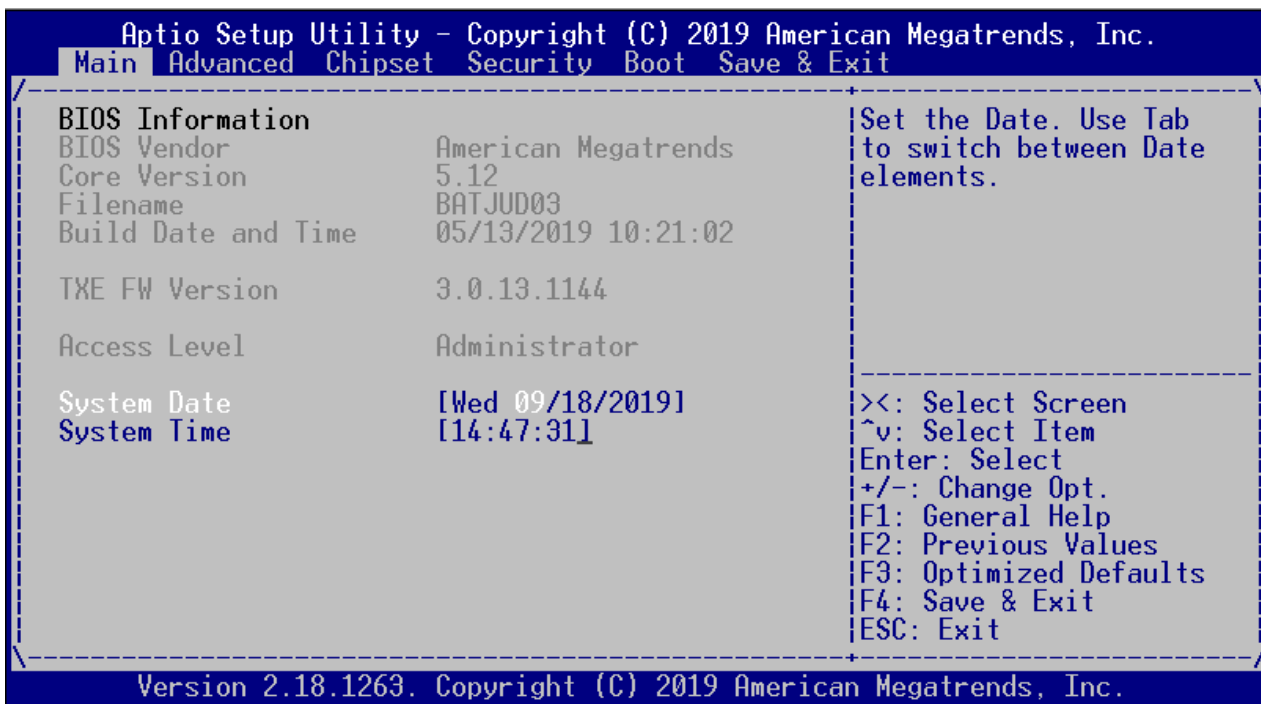

3. After setting, please press “F4” key to save & exit.

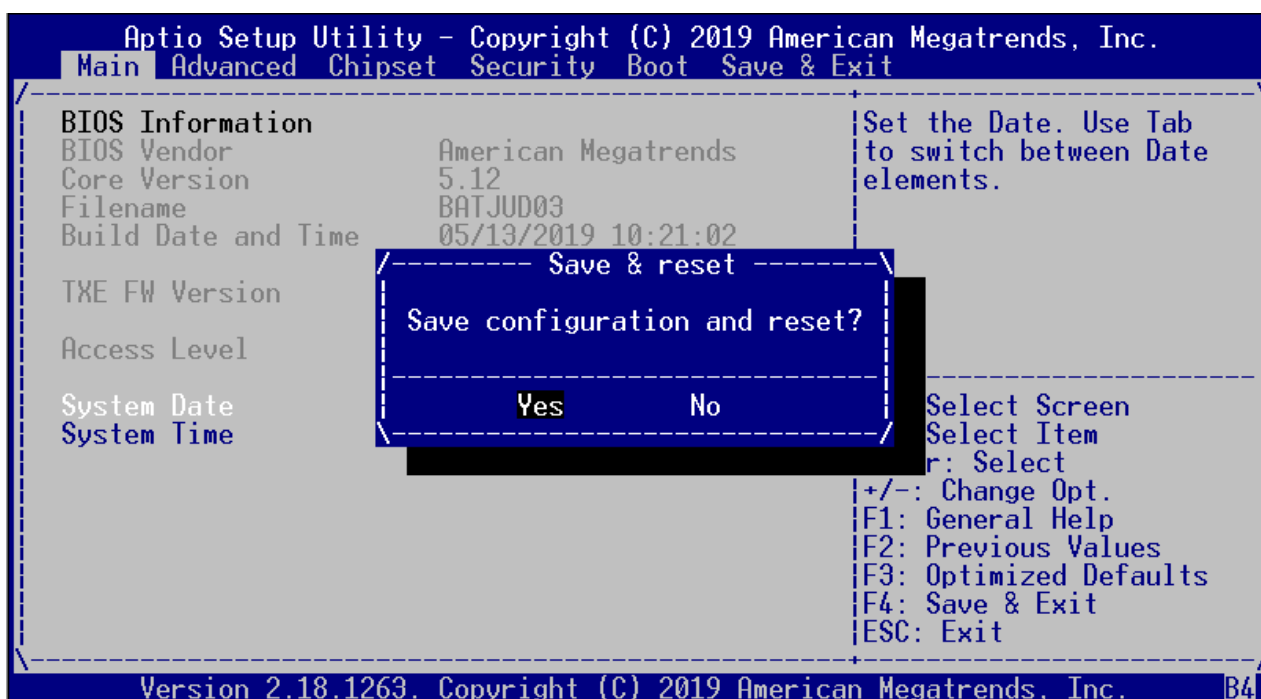

Hot key

Press <F7> after boot up, a shortcut boot up device select menu will appear. Use direction key to select boot device and enter to boot up.

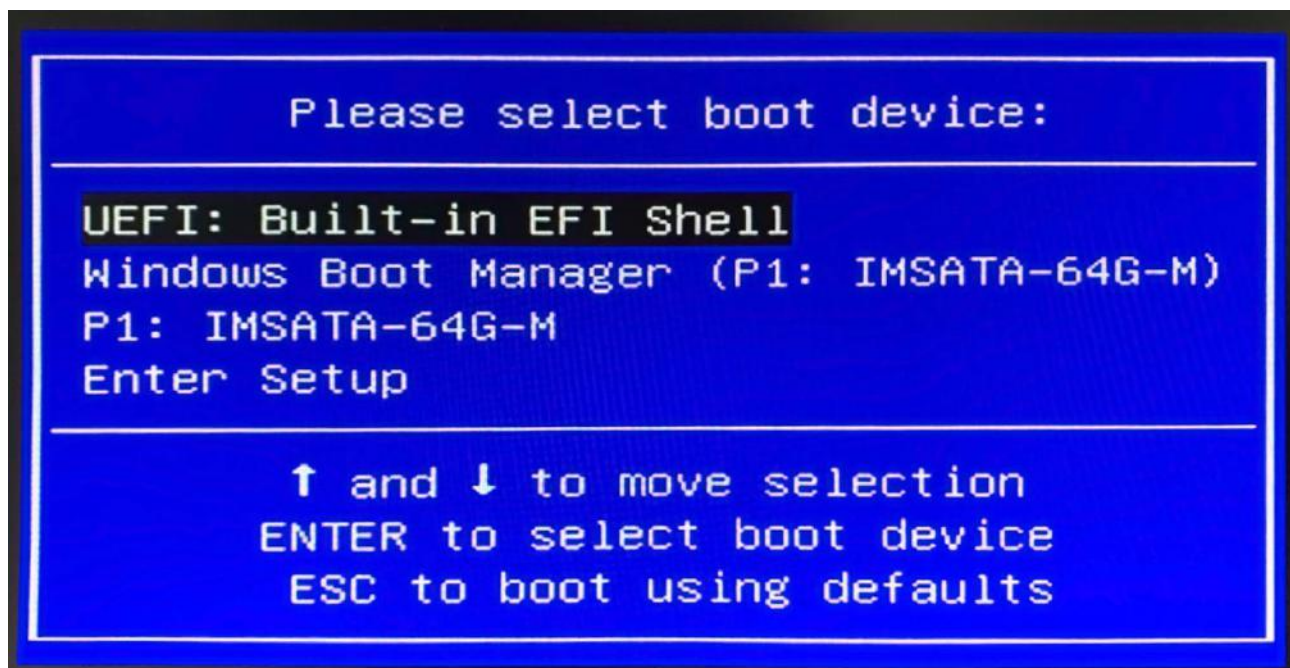

BIOS COM Setting (RS-232/485/422)

1. Press or <Esc> key to enter BIOS menu after boot up, then press <Tab> and move to "Advanced" and "Super IO Configuration".

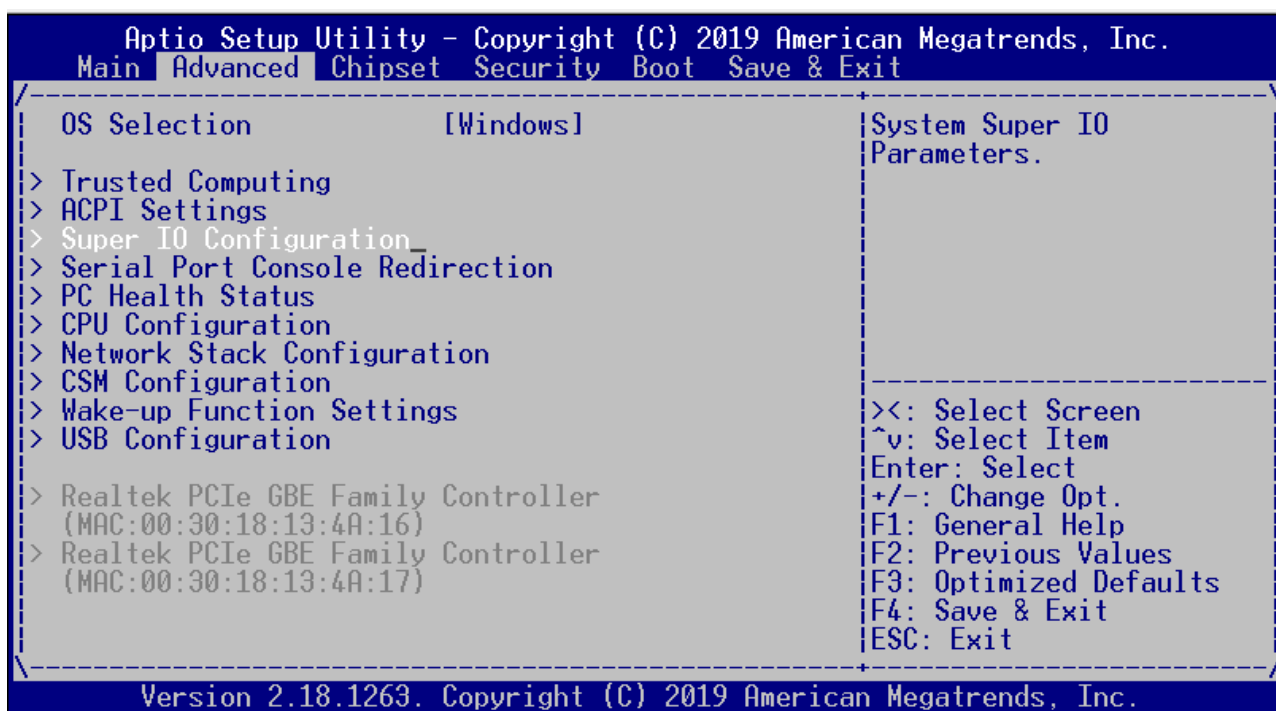

2. Move to "Serial Port 1 Configuration".

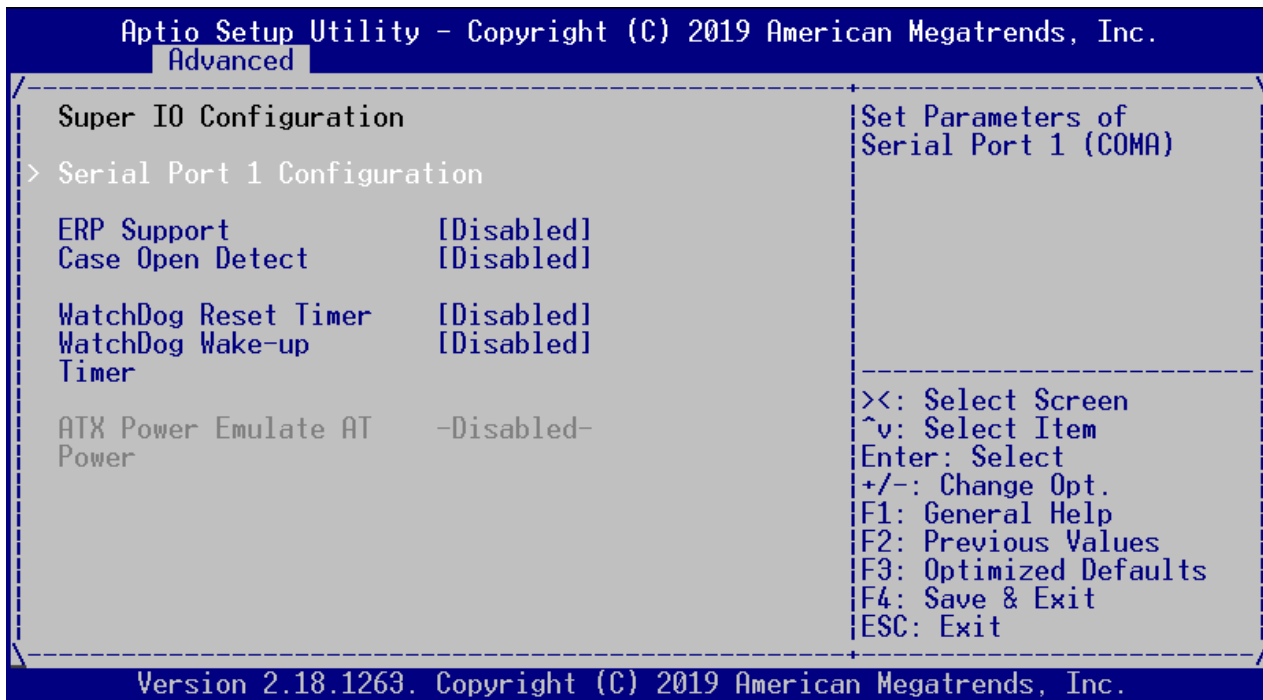

3. Next to Transmission Mode and select COM port Mode.

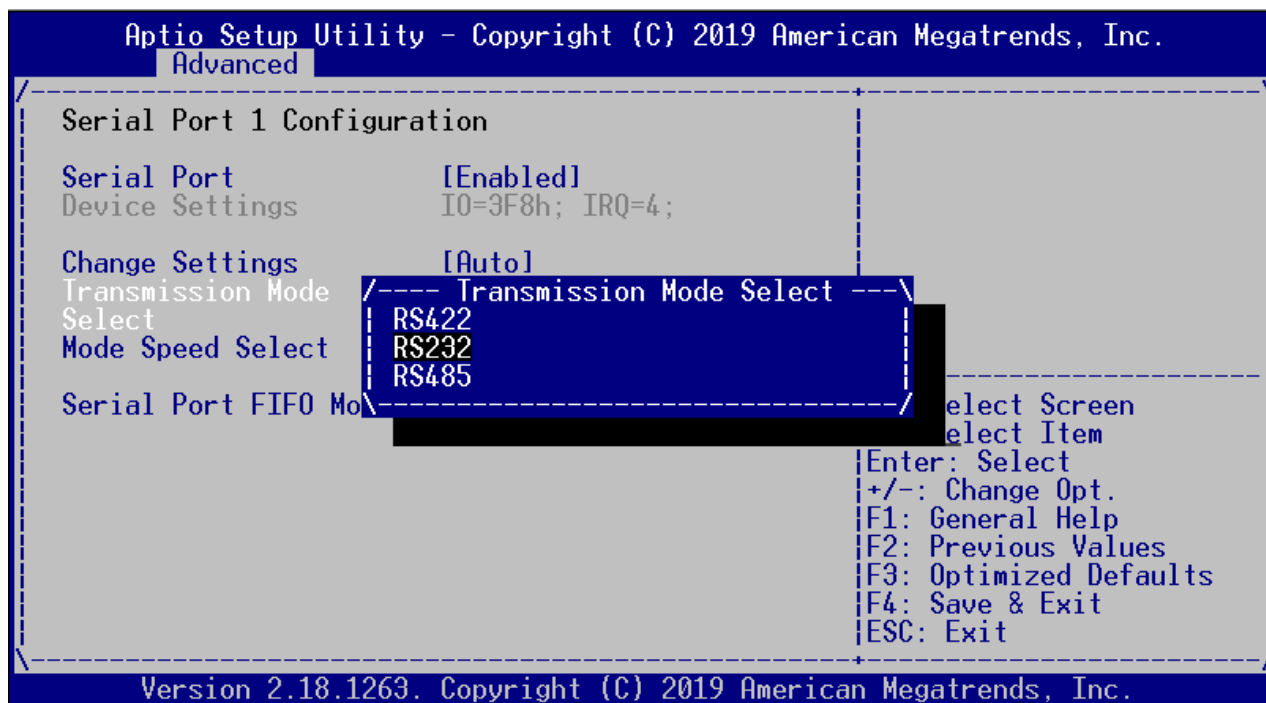

4. Press "F4" key to save & exit.

AT Mode Setting (Auto Power On Function)

EBOX-ALN3350 supports “Auto Power On function”, system will boot up automatically after power restored.

1. In BIOS Menu, move to “Chipset” and “South Cluster Configuration”.

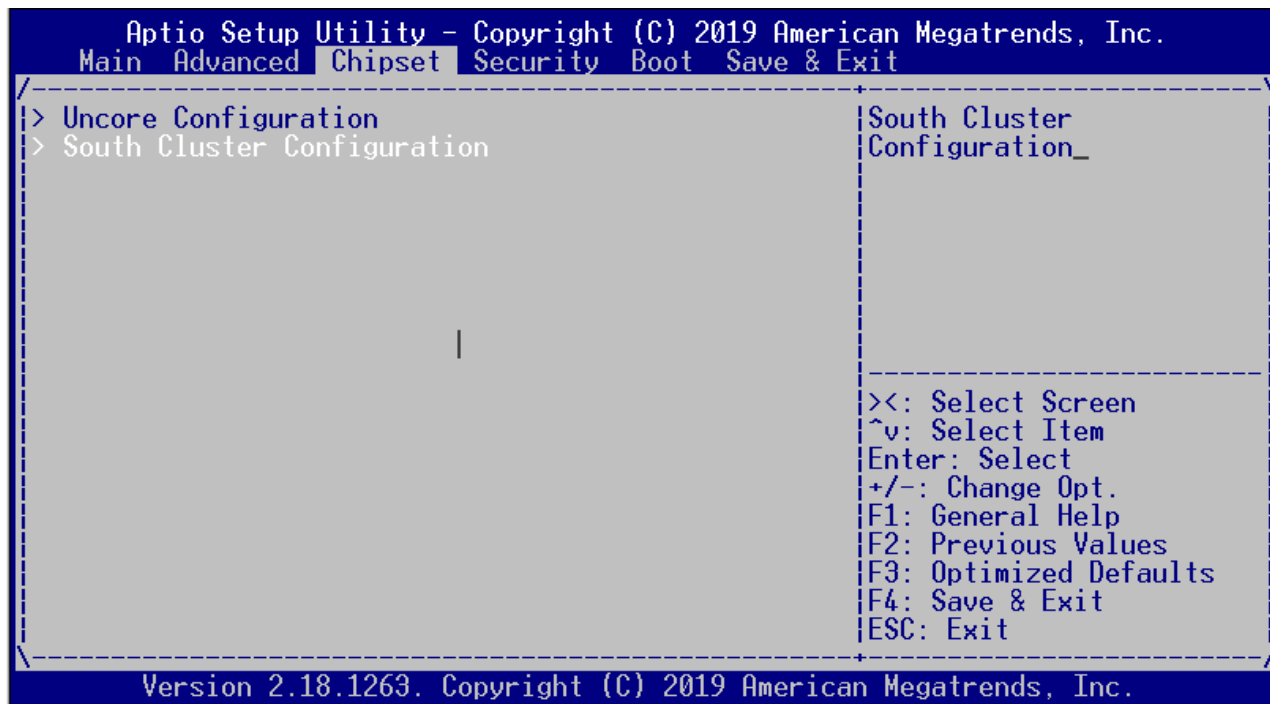

2. Set “System State after Power Failure” as “Always On”, press “F4” key to save & exit.

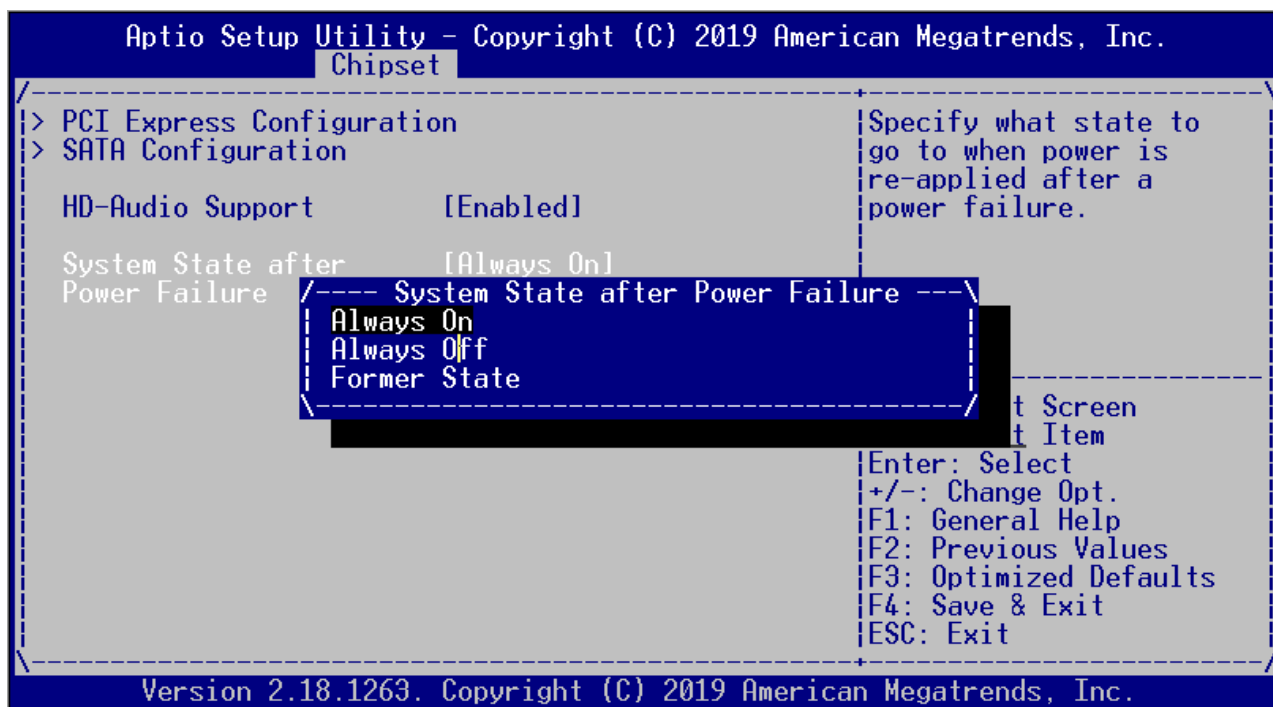

Serial Port Console Redirection

1. Move to “Advanced” and set “Console Redirection” as “Enabled”.

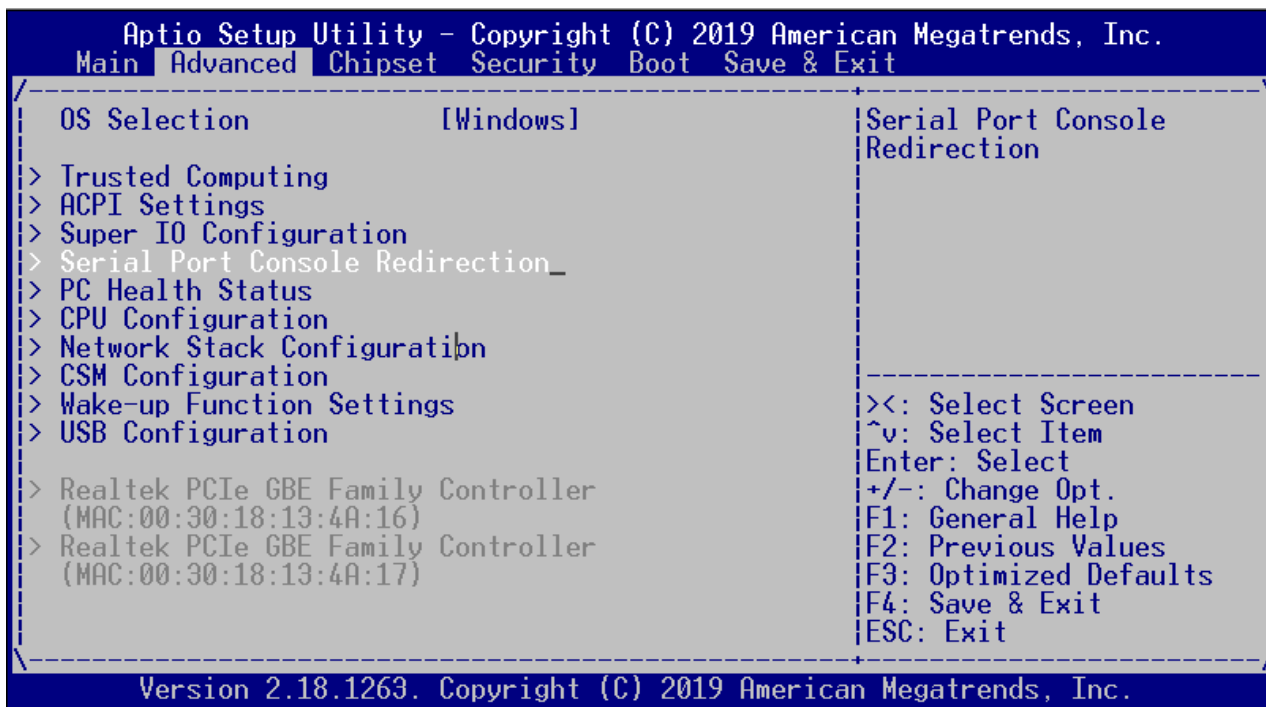

2. Set “Terminal Type” as “VT100+”, press “F4” key to save & exit.

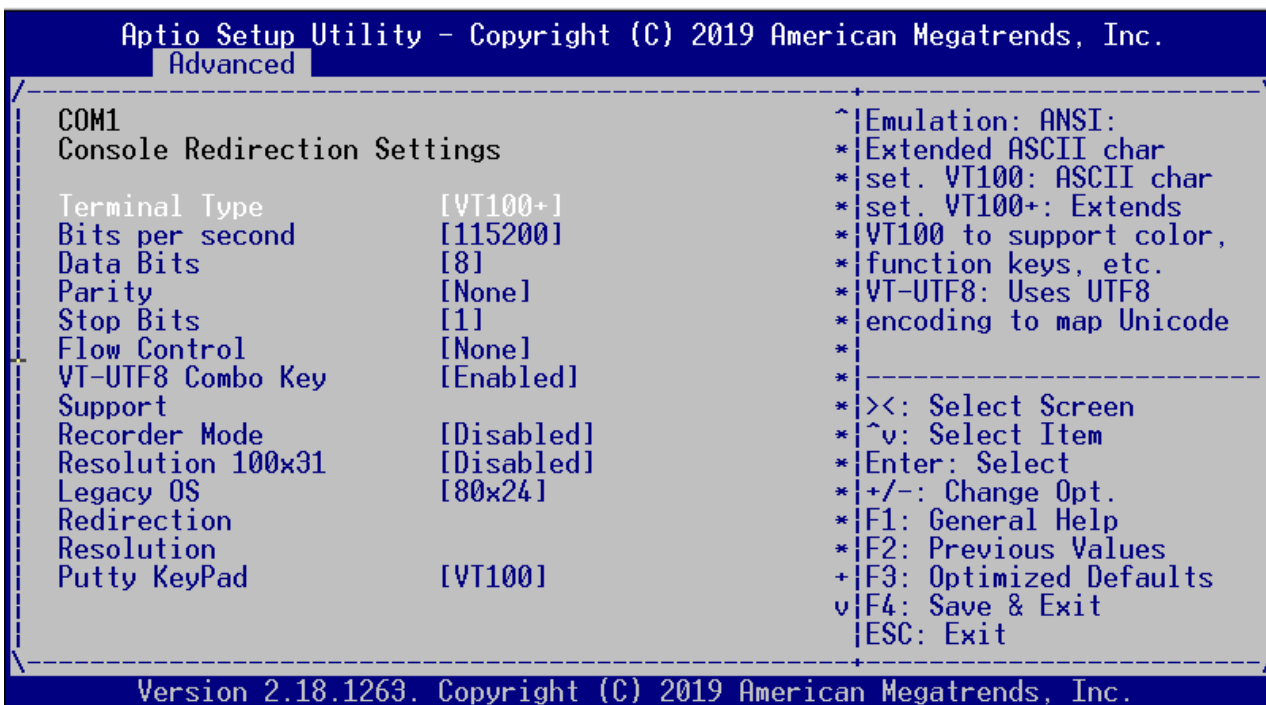

Terminal Type Emulation:

[ANSI]: Extended ASCII char set;

[VT100]: ASCII char set;

[VT100+]: Extended VT100 to support color, function keys, etc.

[VT-UTF8]: Uses UTF8 encoding to map Unicode chars onto 1 or more Bytes.

OS Selection

1. Move to “Advanced” for “OS selection” and set OS mode:

Three optional settings: [Windows], [Intel Linux] and [MSDOS].

Note: User need to go to this item to select the OS mode before installing corresponding OS drivers, otherwise problems will occur when installing drivers.

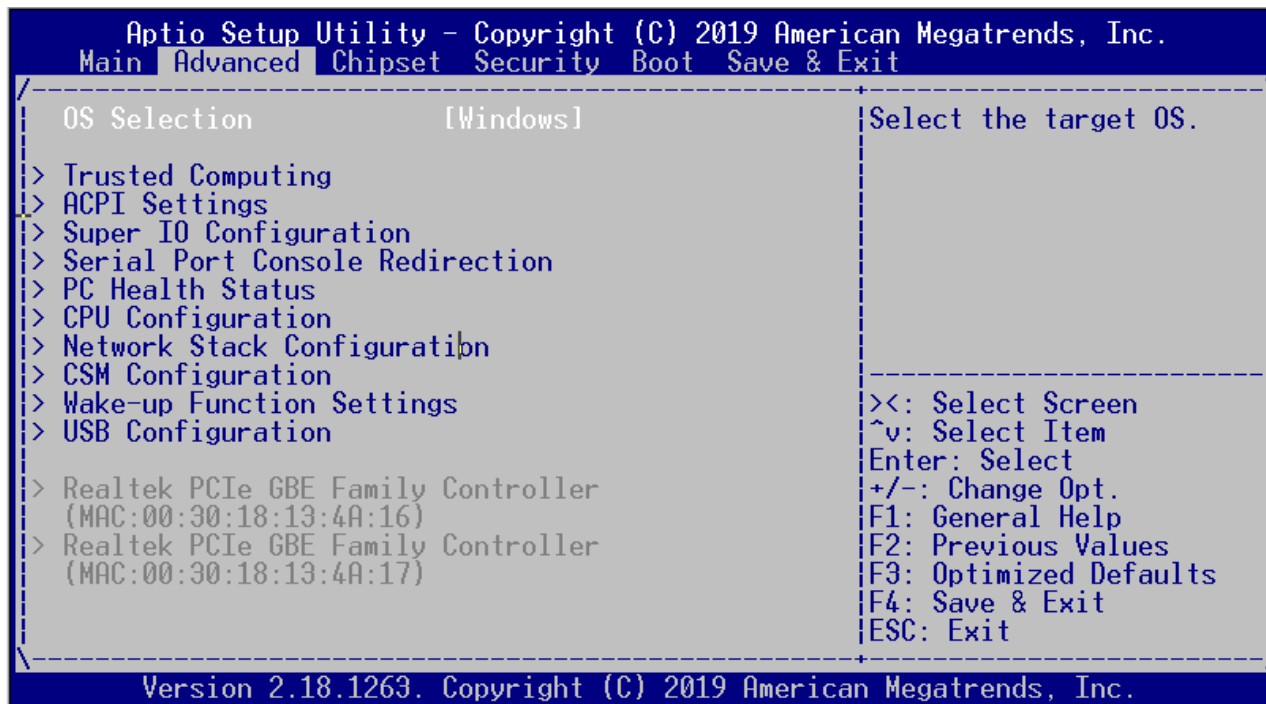

3. After setting, press “F4” key to save & exit.

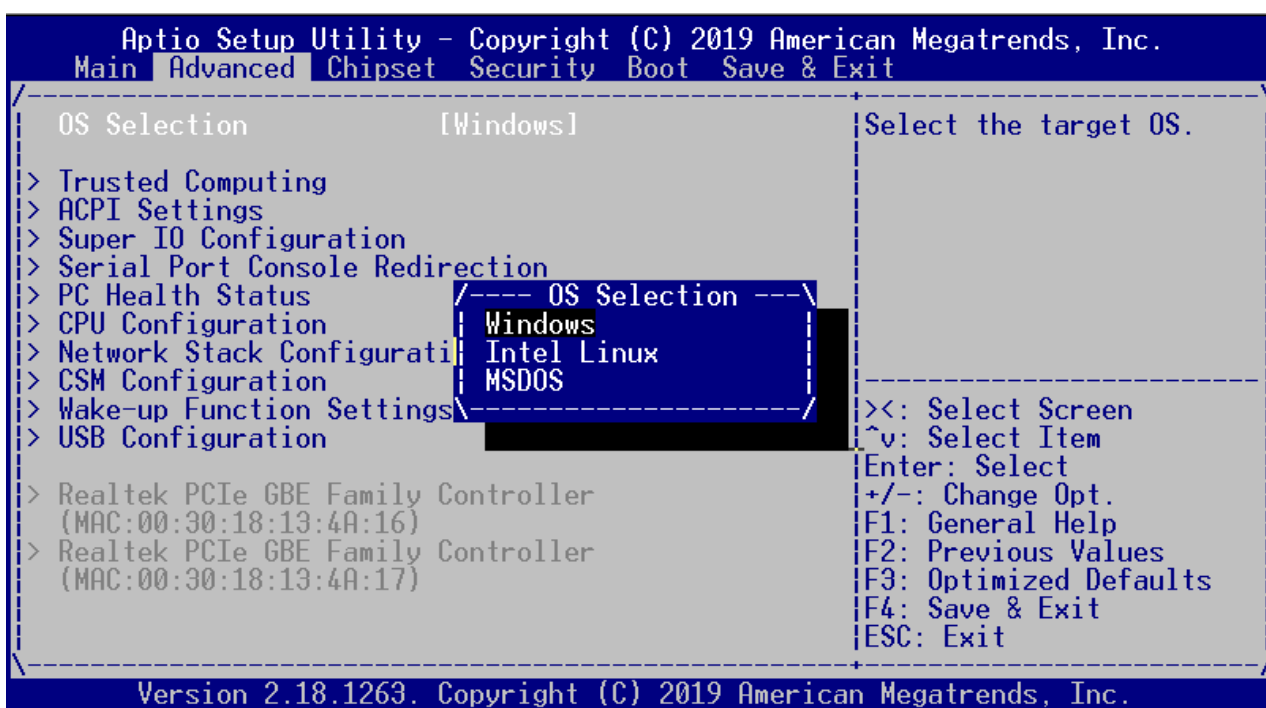

PXE diskless boot Selection

1. Move to “Advanced” for “Network Stack Configuration” and make further setting.

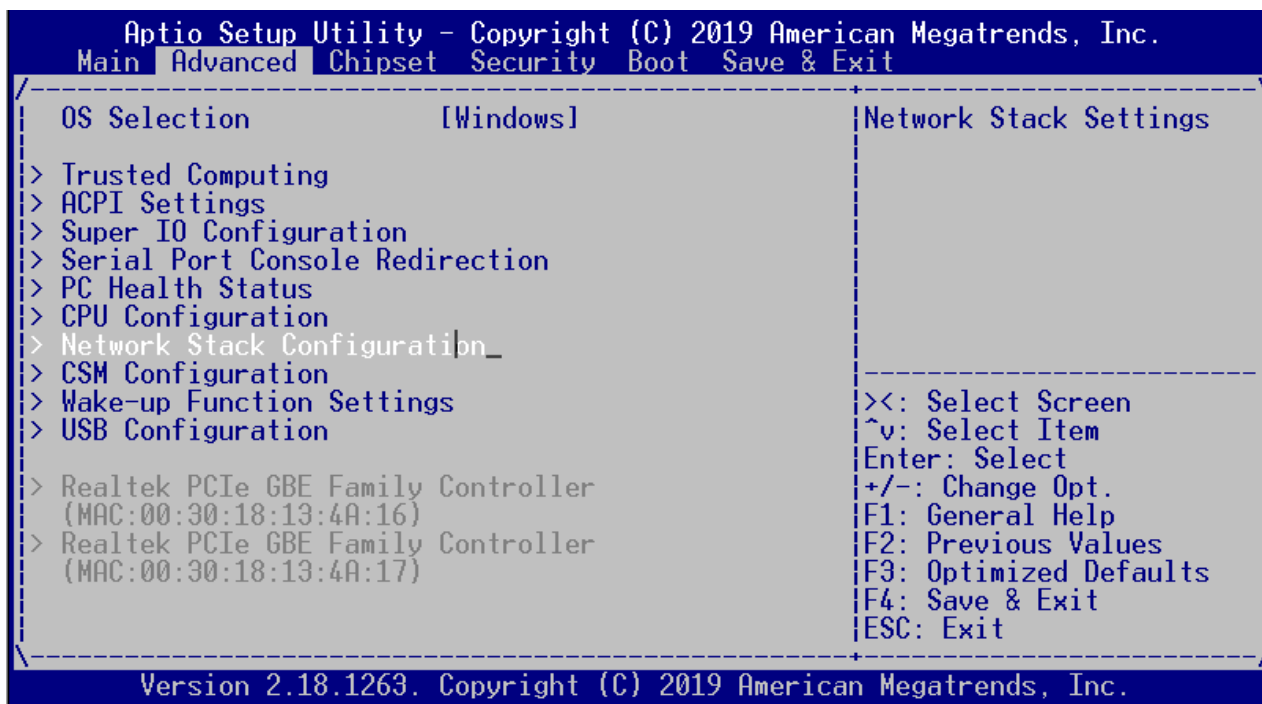

2. Set “Network Stack” Enabled and Ipv4 & Ipv6 PXE Support will appear.

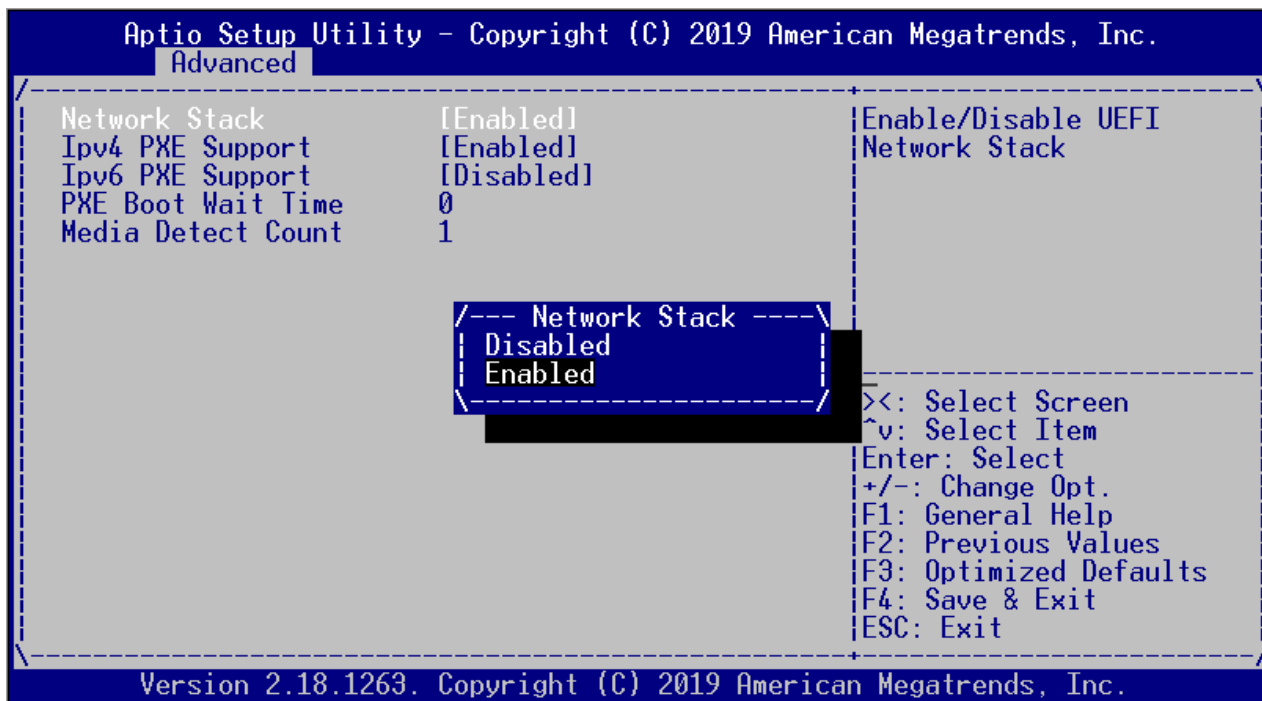

Note: Ipv4 & Ipv6 stand for Internet Protocol version 4 & 6, when set to Enabled, PXE diskless boot will be created.

Drivers Installation guide

Under Windows 10, the following drivers need to be installed manually.

1. Chipset:
2. Graphic
3. Audio
4. LAN
5. TXE
6. iRMT
7. ISH

Please download above drivers from EBOX website.

Chipset driver: (Intel® Chipset Device Software)

1. Unzip the downloaded file and execute SetupChip.exe, then click “Next” to install:

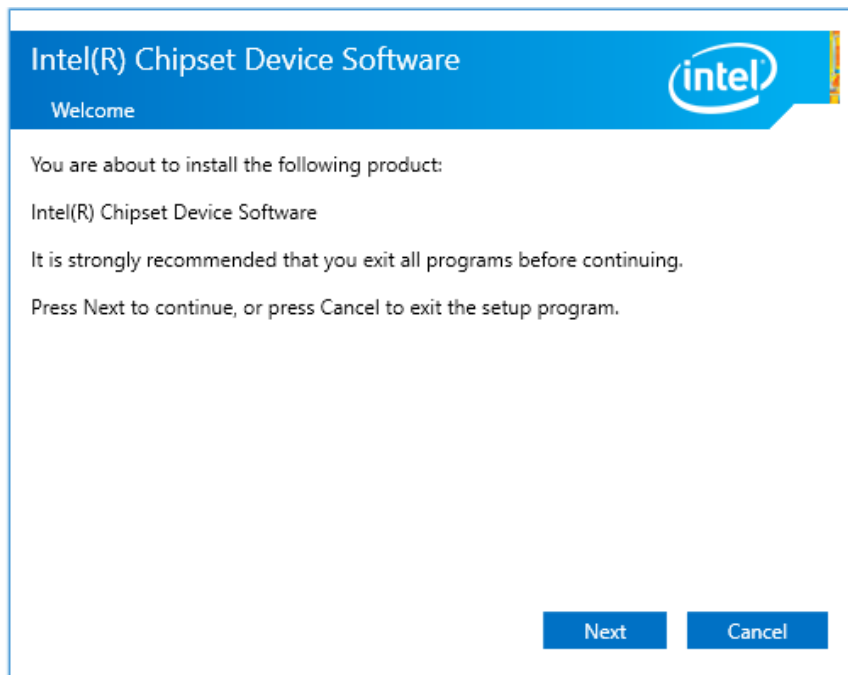

2. A license agreement message will pop out, click Accept and install.
3. Click Finish to complete the setup process.

Graphic driver:

1. Execute igxpin.exe and click “Next” to install:

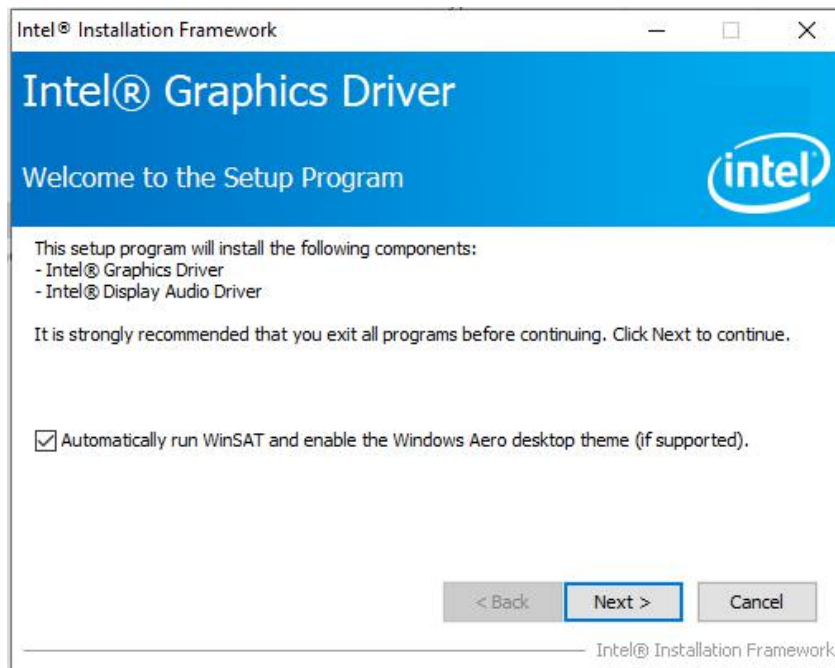

2. A license agreement message will pop out, click Accept and install.
3. After installed, select “Yes, I want to restart this computer now” and click Finish to reboot.

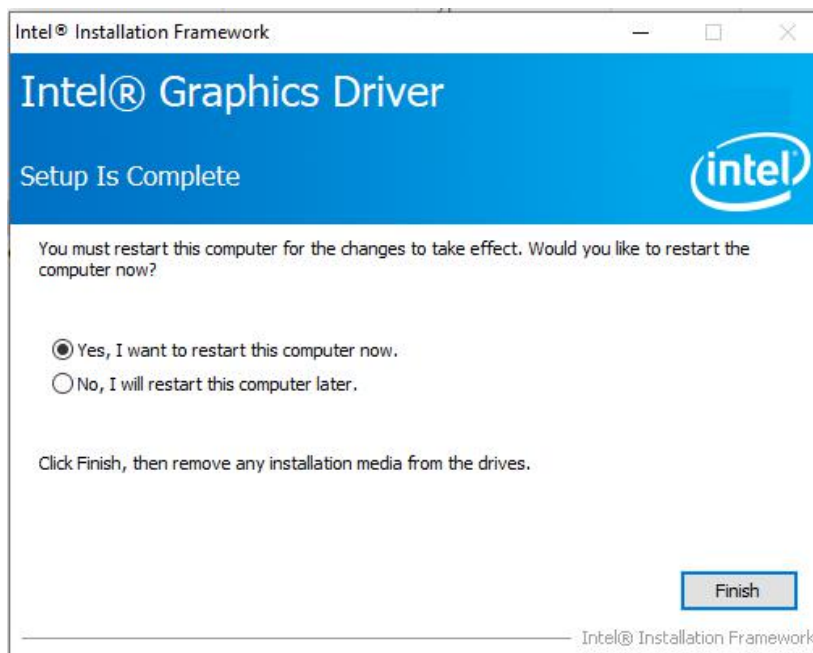

Audio driver:

1. Execute Setup.exe and installer will pop out, then click “Next” to install:



2. After installed, select “Yes, I want to restart this computer now” and click Finish to reboot.

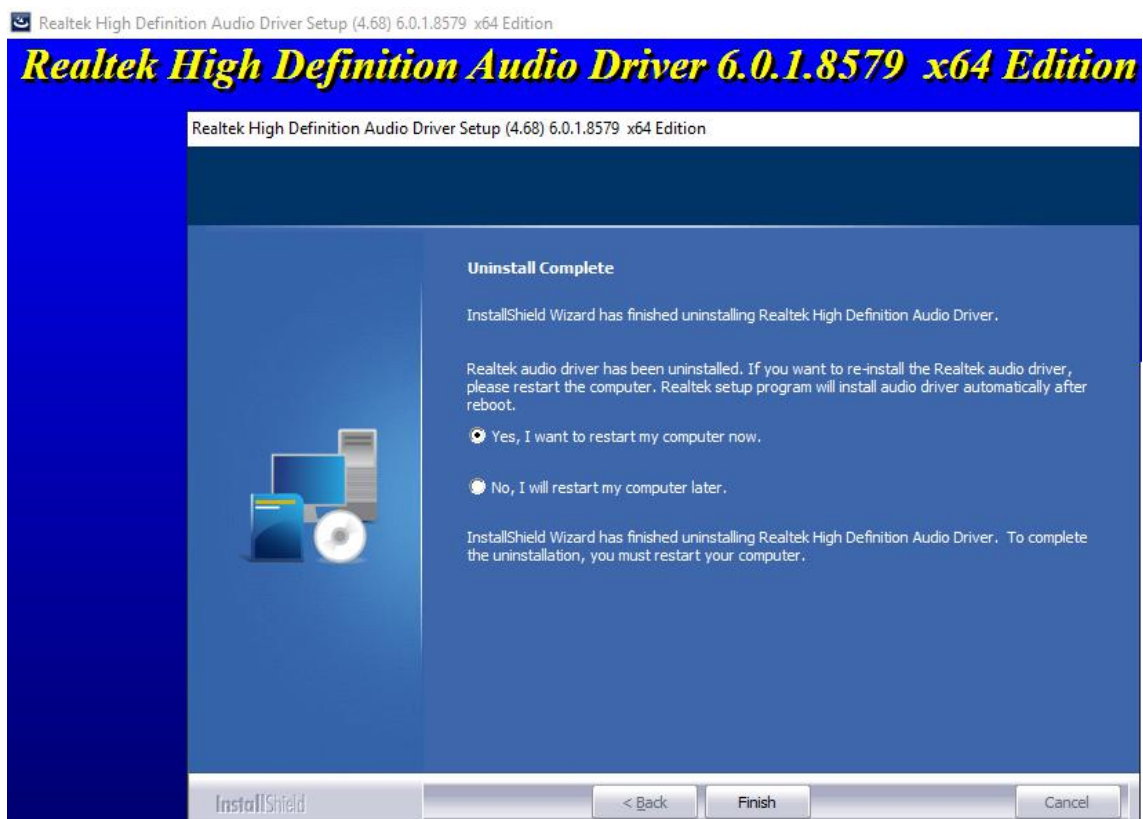

LAN driver:

1. Execute Setup.exe and InstallShield Wizard will pop out, then click “Next” to install:

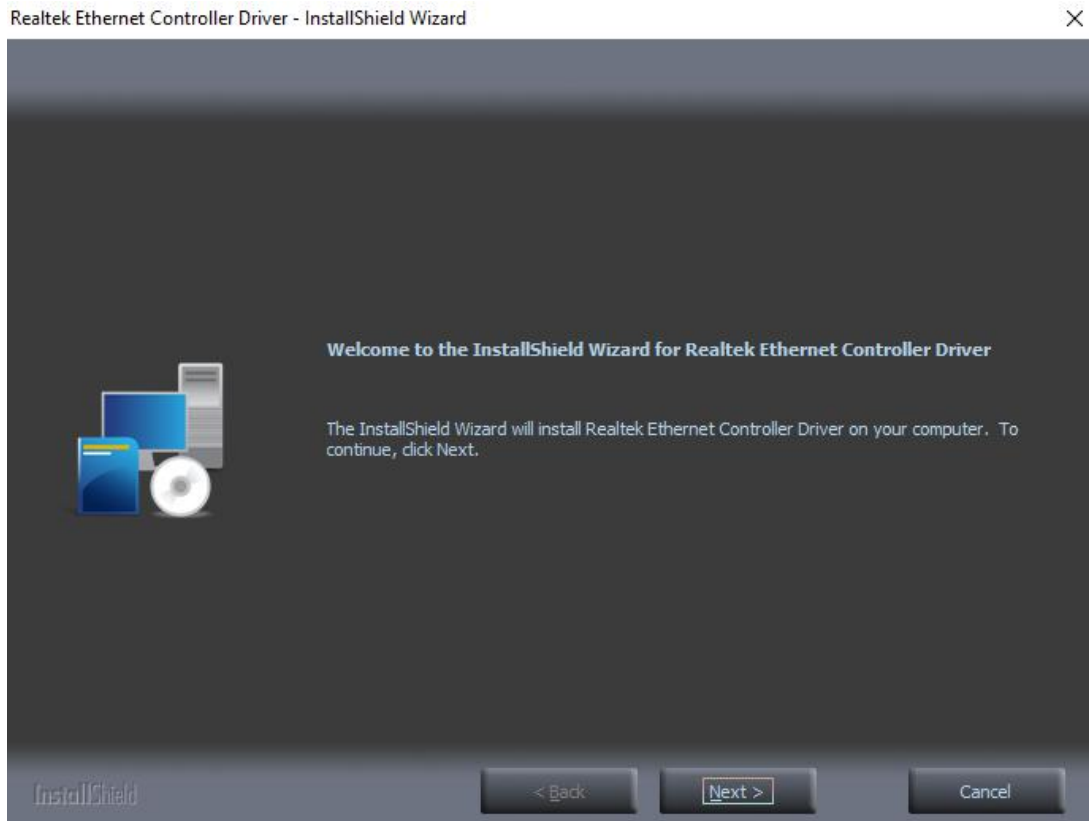

2. After installed, click “Finish” to exit the wizard.

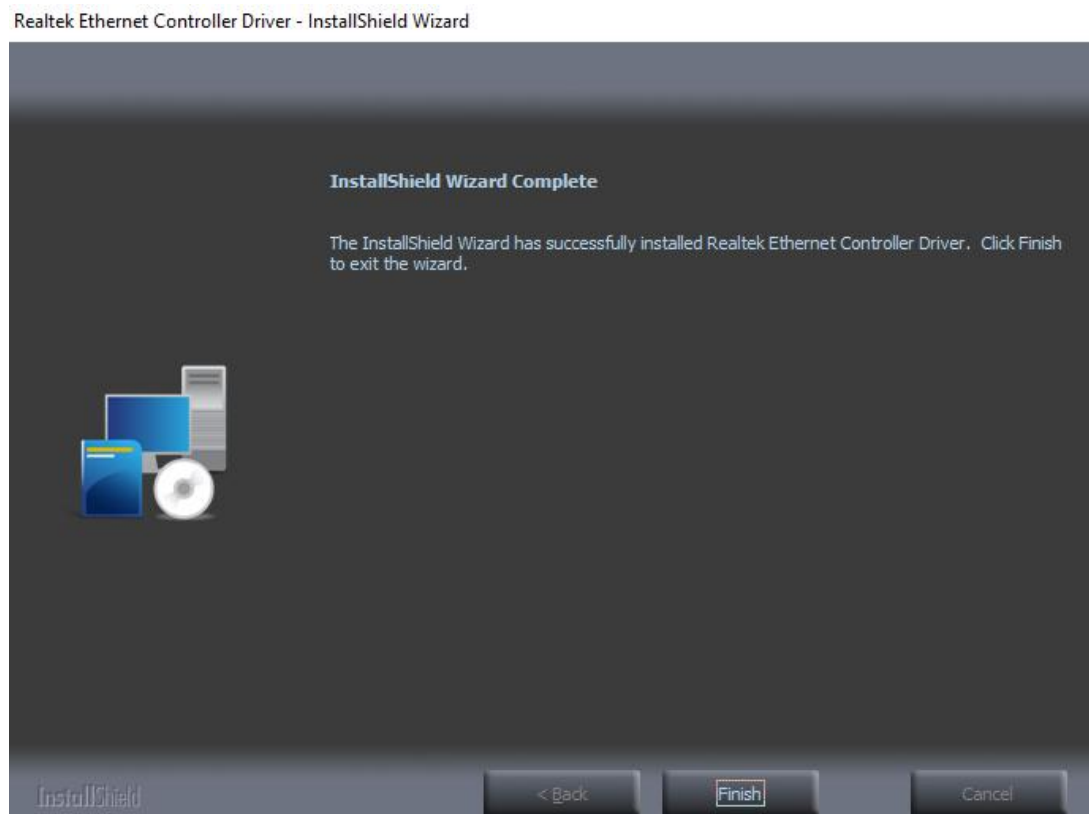

TXE driver: (Intel® Trusted Execution Engine)

Trusted Execution Engine is a computer hardware technology primary goals are: Attestation of the authenticity of a platform and its operating system.

1. Execute SetupTXE.exe and click “Next” to install:

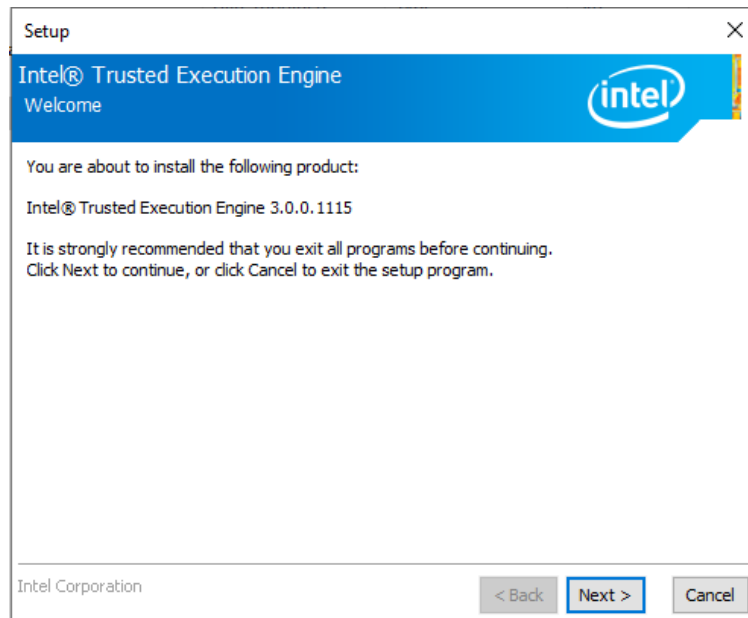

2. Check “I accept the term in the License Agreement and click “Next” to install.

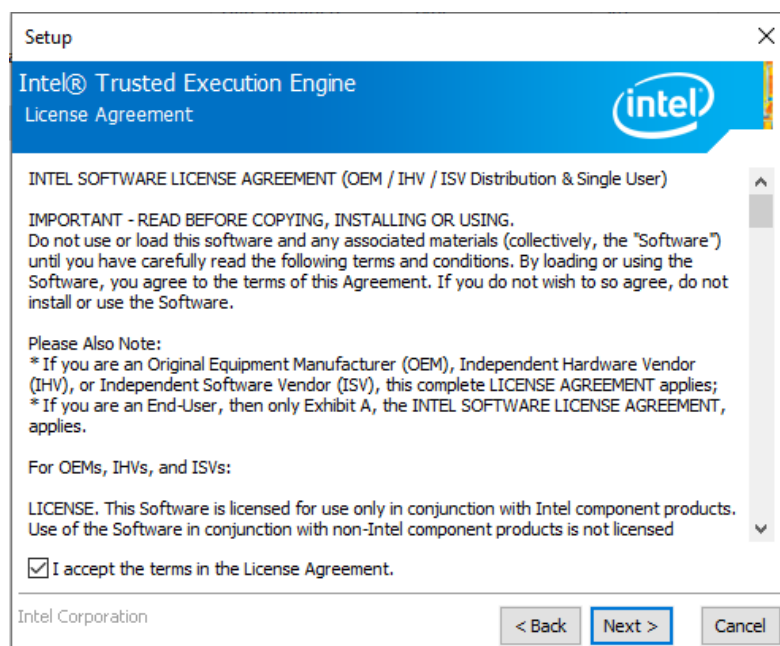

3. Click “Finish” after successfully installed.

iRMT driver: (Intel® Ready Mode Technology)

With Intel® Ready Mode Technology (Intel® RMT), system can deliver the latest updates so users don't have to worry about missing out. Intel® RMT provides with an alternative to the traditional PC sleep state. When system receives incoming emails, real-time news, social media posts, and weather alerts—all while minimizing power consumption when it isn't actively being used.

1. Execute Setup.exe and click “Next” to install:

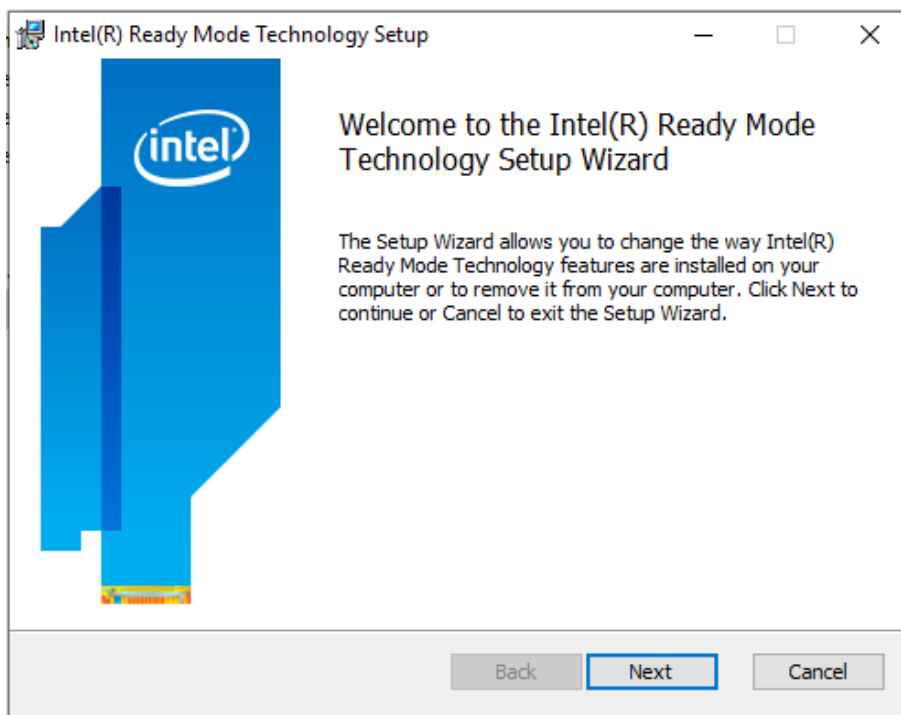

2. Check “I accept the term in the License Agreement and click “Next” to install.

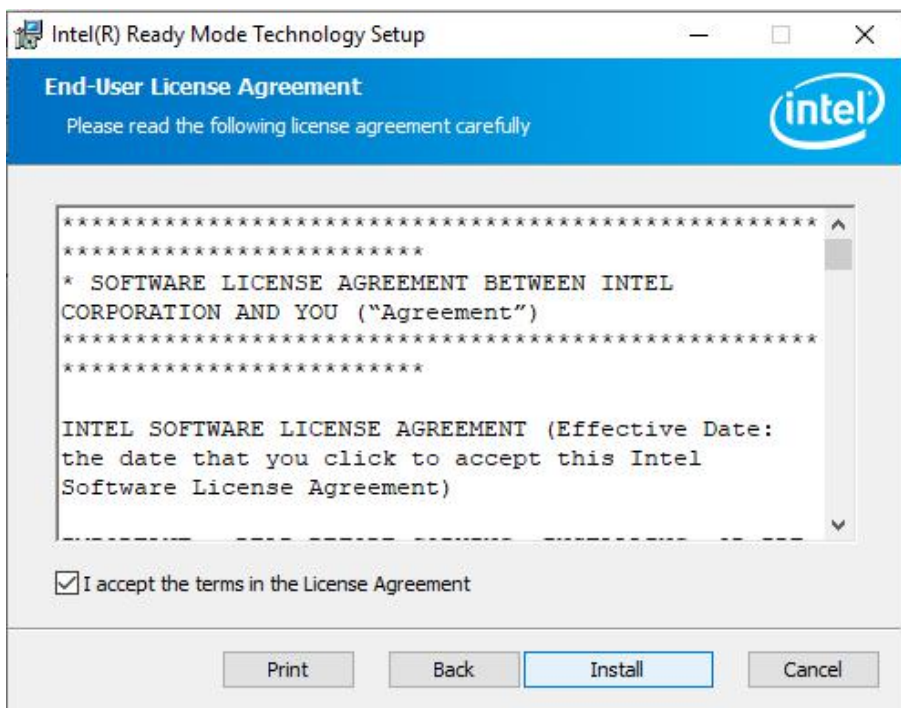

3. Click “Finish” after successfully installed.

ISH driver: (Intel® Integrated Sensor Solution)

Intel® Integrated Sensor Solution installs Intel Integrated Sensor Solution driver to EBOX.

1. Double click SetupISS.exe and click install.

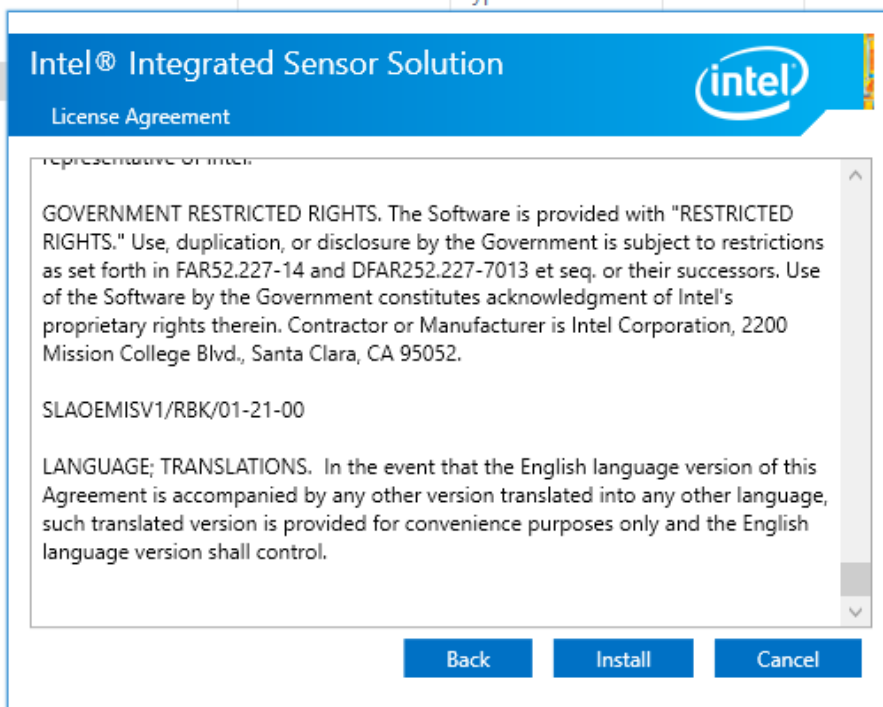

2. Click "Finish" after successfully installed.

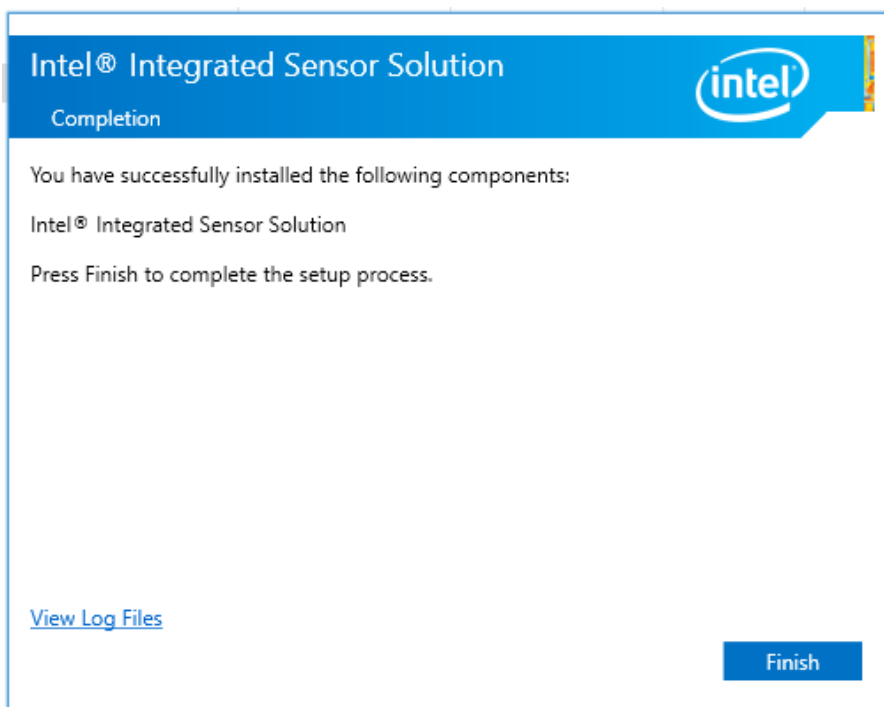

Chapter4

Onboard Connectors Summary

Summary Table for CPU Board

No.	Description	Type of Connections	Pin nbrs.
J1	DDR3L SO-DIMM Slot	SO-DIMM slot	204-pin
J2	Power DC Jack	DC Jack connector	2-pin
J3	HDMI x 2	HDMI connector	19-pin
J4	VGA	D-Sub connector	15-pin
J5	SATA	SATAIII port connector	7-pin
J6	SATA power output	2.54mm 4-pin header	4-pin
J7	Full-size mPCIe/ co-lay mSATA	mPCIe connector	52-pin
J8	Half-size mPCIe	mPCIe connector	52-pin
J9	Ethernet x 2	G-LAN RJ45 connector	8-pin
J10	SIM card holder	SIM card holder	6-pin
J11	Audio jack	Mic in/Line out Combo connector	2-pin
J12	USB 3.0 x 4	USB 3.0 connector	9-pin
J13	COM (RS-232/485/422)	2.0mm 9-pin header	9-pin

Pin Assignments

J2: DC Power Input

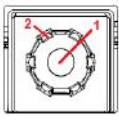
	Pin #	Signal Name
	1	+12VDC
	2	GND

J3: HDMI

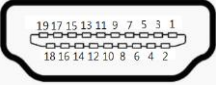
	Pin #	Signal Name	Pin #	Signal Name
	1	TMDS_Data2+	11	TMDS CLK Shield
	2	TMDS_Data2_Shield	12	TMDS_CLK-
	3	TMDS_Data2-	13	CEC
	4	TMDS_Data1+	14	Reserved
	5	TMDS_Data1_Shield	15	SCL
	6	TMDS_Data1-	16	SDA
	7	TMDS_Data0+	17	DDC/CEC_GND
	8	TMDS_Data0_Shield	18	+5V Power
	9	TMDS_Data0-	19	Hot Plug Detect
	10	TMDS_CLK+		

J4: VGA – 15-pin D-Sub connector

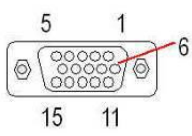
	Pin #	Signal Name	Pin #	Signal Name	Pin #	Signal Name
	1	MR	6	GND	11	NC
	2	MG	7	GND	12	VCC
	3	MB	8	GND	13	HYSYNC
	4	NC	9	NC	14	VSYNC
	5	GND	10	GND	15	VCC

J5: SATAIII connector

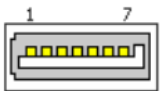
	Pin #	Signal Name	Pin #	Signal Name
	1	GND	5	Receive-
	2	Transmit+	6	Receive+
	3	Transmit-	7	GND
	4	GND		

J7: Full-size mPCIe

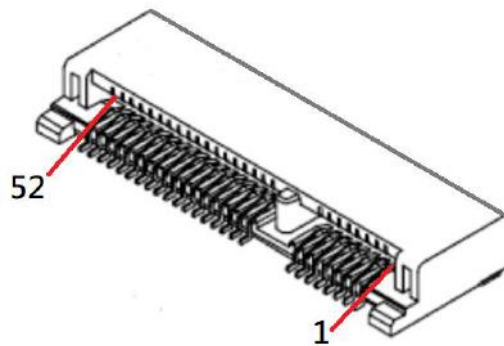

Mini PCI Express x1

	Pin N/B	Pin N/B	
3.3V	2	1	WAKE#
GND	4	3	COEX1 / NC
1.5V	6	5	COEX2 / NC
UIM_PER	8	7	CLKREQ#
UIM_DATA	10	9	GND
UIM_CLK	12	11	REFCLK-
UIM_PESET	14	13	REFCLK+
UIM_VCCP / NC	16	15	GND
Mechanical Key			
GND	18	17	Reserved / NC
W_DISABLE#	20	19	Reserved / NC
RESET#	22	21	GND
3.3V	24	23	PERNO / MSATA_RXP
GND	26	25	PERPO / MSATA_RXN
1.5V	28	27	GND
SMB_CLK	30	29	GND
SMB_DATA	32	31	PERTNO / MSATA_TXN
GND	34	33	PERTPO / MSATA_TXP
USB_D-	36	35	GND
USB_D+	38	37	GND
GND	40	39	3.3V
LED_WWAN# / NC	42	41	3.3V
LED_WLAN# / NC	44	43	GND
LED_WPAN# / NC	46	45	Reserved / NC
1.5V	48	47	Reserved / NC
GND	50	49	Reserved / NC
3.3V	52	51	MSATA_DET

J8: Half-size mPCIe

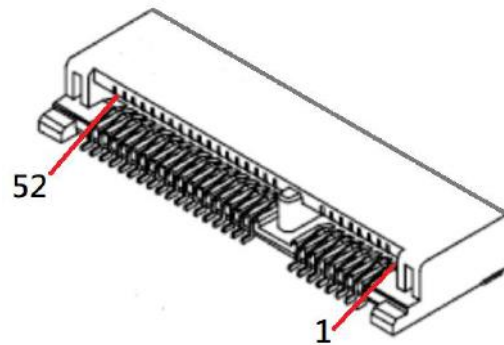

Mini PCI Express x1

	Pin N/B	Pin N/B	
3.3V	2	1	WAKE#
GND	4	3	SERIRQ
1.5V	6	5	COEX2 / NC
LFRAME_N	8	7	CLKREQ#
LAD3	10	9	GND
LAD2	12	11	REFCLK-
LAD1	14	13	REFCLK+
LAD0	16	15	GND

Mechanical Key

GND	18	17	PLTRST_N
W_DISABLE#	20	19	LPC_CLK
RESET#	22	21	GND
3.3V	24	23	PERNO
GND	26	25	PERPO
1.5V	28	27	GND
SMB_CLK	30	29	GND
SMB_DATA	32	31	PERTNO
GND	34	33	PERTPO
USB_D-	36	35	GND
USB_D+	38	37	GND
GND	40	39	3.3V
LED_WWAN# / NC	42	41	3.3V
LED_WLAN# / NC	44	43	GND
LED_WPAN# / NC	46	45	Reserved / NC
1.5V	48	47	Reserved / NC
GND	50	49	Reserved / NC
3.3V	52	51	Reserved / NC

J10: LAN: RJ-45 connector

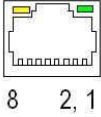
	Pin #	Signal Name	Pin #	Signal Name
	1	TP0+	5	TP2-
	2	TP0-	6	TP1-
	3	TP1+	7	TP3+
	4	TP2+	8	TP3-

J10: LAN: RJ-45 connector

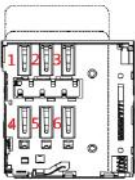
	Pin #	Signal Name	Pin #	Signal Name
	1	SIM-VCC	4	GND
	2	SIM-RST	5	SIM-VPP
	3	SIM-CLK	6	SIM-IO

J12: USB 3.0 connector

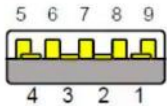
	Pin #	Signal Name	Pin #	Signal Name
	1	5V	6	Receive+
	2	DATA-	7	GND
	3	DATA+	8	Transmit-
	4	GND	9	Transmit+
	5	Receive-		

J13: RS-232/485/422 9-pin D-Sub connector

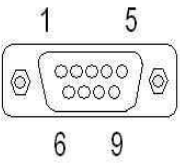
	Pin #	Signal Name	Pin #	Signal Name
	1	DCD/ RS-422 TX-/ RS-485 DATA-	6	DSR1
	2	RXD/ RS-422 TX+/ RS-485 DATA+	7	RTS1
	3	TXD1/ RS-422RX+	8	CTS1
	4	DTR1/ RS-422RX-	9	R 1
	5	GND	--	--

LEDS: POWER ON/ OFF

	LED Color	State
	Blue	Power On

Chapter 5

Taking Care of EBOX

This section provide guidelines on using EBOX-ALN3350/ ALJ3455 – Safe using, Storing and Handling.

Storing

- ▶ Do not place EBOX in a location that is subject to:
 - Heating sources, such as stove, oven, heater, radiator or air duct
 - Direct contact from sunlight
 - Rain or moisture area
 - Excessive dust accumulation area
 - High humidity place
 - Constant or occasional mechanical movement, vibration or shock
 - Strong magnets or magnetic fields or magnetically unshielded speakers
 - Out of the operating temperature
- ▶ Do not place other electronic device or electrical equipment near EBOX. The electromagnetic field of EBOX may cause interference subjecting to malfunction.
- ▶ Provide adequate air ventilation (circulation) to prevent internal buildup of heat. Do not place EBOX near behind the curtains or draperies, in between two books that block its ventilation slots. Leave a space of at least 8 inches (20cm) behind the sides and back panel of the EBOX.
- ▶ Change of environmental temperature: Problems may occur when there is a sudden change of environmental temperature, or if the EBOX is brought directly from a cold location to a warm one, moisture may condense inside EBOX. Turn off the device, and contact your nearest dealer.
- ▶ Check the surrounding appliance(s) before using EBOX. Since the EBOX uses high-frequency radio signal and may interfere with radio or TV reception causing interference or poor signal display. When happens, relocate the EBOX by a suitable distance away from it.
- ▶ Do not drop EBOX from working table nor place heavy objects on top of it.

Cleaning EBOX

- ▶ Clean EBOX with a soft, dry cloth or a soft cloth lightly moistened with a mild detergent solution.
- ▶ Do not use any type of abrasive pad, scouring powder, or solvent such as alcohol or benzene, as these may damage the finish of EBOX.
- ▶ When a solid object falls or a liquid spills onto EBOX, turn off EBOX immediately; unplug the LAN and power cables. Contact a qualified person or your dealer to check the EBOX before you use it again.
- ▶ Always disconnect the power cord from the power source before cleaning EBOX.

Troubleshooting

This section describes the techniques of resolving some basic problems that you encounter when using EBOX. For more troubleshooting guidelines, please contact your nearest dealer for technical support.

Troubleshooting EBOX

A. EBOX does not start –

- ▶ Make sure EBOX is properly secured and plugged into a power source before it is turned on.
- ▶ Make sure the power indicator shows the power is on.
- ▶ When EBOX unit is plugged into a power strip or the UPS (Uninterruptible Power Supply), make sure the power strip or UPS is turned on and working normally.
- ▶ Check if your display monitor is properly plugged into a power source and turned on. Make sure the brightness and contrast controls are adjusted correctly. See the manual that came with display (monitor) for details.
- ▶ Check if power control button function well by removing the AC adaptor. Wait for one minute, and then reattach all power connection before pressing the power button.
- ▶ Condensation may cause EBOX malfunction for a while. If happens, do not use EBOX for at least one hour.
- ▶ When all above guidelines checked and EBOX unit still not work. Remove the power adaptor from EBOX, unplug the power supply, and plug it in again. Then turn on the power.

B. BIOS Error Message –

BIOS error message appears when EBOX starts

If BIOS error message appears, press any key to resume or, press to enter BIOS setup main menu, follow these steps:

1. Press or <Esc>, and the BIOS Setup main menu appears, check if storage is detected. If it is not detected, use Direction keys <↑↓> to choose "AUTO" and then go back to the main menu by pressing <Esc>. Move your cursor down with Direction keys <↓>, and press F4 to "Save and Exit",
2. Go to "Save & Exit" menu using the Direction keys <↑↓> and choose the option "Restore Defaults", then press <Enter>. A message dialog appears as seen below, hit "Y" key and presses <Enter> to save and recover to the factory setting.

"Restore Defaults (Y/N)? Y"

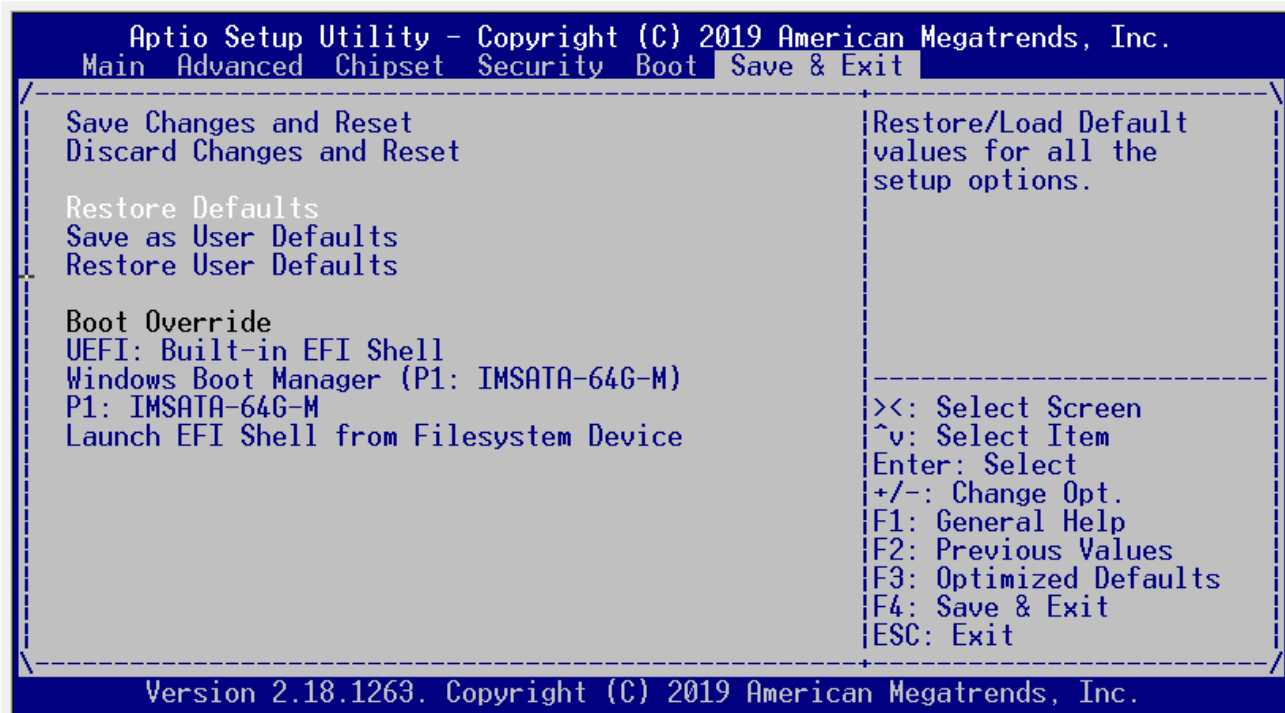

(BIOS Setup menu "Save & Exit")

C. "Operating System Not Found" –

A message indicating "Operating system not found" appear when unit starts (Windows won't start)

- ▶ Enter BIOS setup main menu by pressing key, be sure that the C: drive is enable.
- ▶ If Windows still does not start, follow these steps to initialize the BIOS:
 1. Turn off EBOX unit.
 2. Remove any peripheral devices connected to EBOX unit.
 3. Restart EBOX unit.
 4. Press or <Esc> to enter BIOS Setup main menu window.
 5. Follow the steps as written in item **B. BIOS error message**.
- ▶ If EBOX unit connected to a CD/ DVD or USB Drivers, remove all peripherals. And restart to check if Windows operating system starts properly. If EBOX unit continues to display the message "Operating system not found," and Windows does not start, please contact nearest dealer for servicing.

Chapter 6

Terms and Conditions

Warranty

The warranty terms for EBOX are twelve (12) months from the shipped month. During the warranty period, DMP Electronics will repair replace the product covered under this limited warranty.

Service and Support

DMP Electronics Inc. provides the technical support for hardware problems with your system throughout the warranty period. The technical support service is limited to configuration and operation of EBOX sold by DMP Electronics Inc. The technical support service does not offer software tutoring or training.

Return Merchandise Authorization (RMA) policy

If the DMP staff or dealer determines that a part is defective. Purchaser must call our technical support service to obtain an RMA number before attempting to return any part. Please refer to your nearest dealer for:

To obtain an RMA number, Purchaser must follow procedures as below :

1. Complete the DMP Electronics Inc. standard RMA Form and fax back to the RMA Department.
2. The RMA Number must be used within 7 DAYS.
3. The RMA Number must be shown clearly on your shipping label.
4. DMP Electronics Inc. must receive all Returns before a replacement will be sent.
5. Repair cost depends on the parts, damage reasons, and whether under warranty period...etc. The Seller will charge the Purchaser in a reasonable price.
6. A copy of the invoice for the RMA product(s) will also be shipped to Purchaser.
7. The freight of return to DMP Electronics Inc. is charged to the Purchaser's account and accompanied by an RMA number. Any Returns with freight collect will be refused and returned to you. After Repairing, the cost of freight will be paid by Seller.
8. DMP Electronics Inc. must receive all returned goods within the warranty period.

Shipping Policy

The Purchaser must pre-pay shipping for any defective system or parts returned under the warranty. DMP Electronics Inc. shall not be liable for risk of loss or damage during shipment of the returned system or parts if you fail to insure the shipment. All products must be shipped back to DMP Electronics Inc. in original or equivalent packaging. DMP Electronics Inc. will ship the repaired or replacement product(s) to the Purchaser by freight prepaid. Purchaser assumes the risk of loss. DMP Electronics Inc. shall not be responsible for failure of the delivery service to make on-time delivery.