

# Industrial Computing

## Products and Services

Panel PC's



Industrial PC's



SBC's



Electronic Design



Industrial Displays

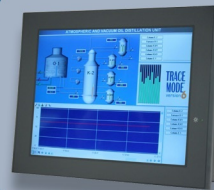

Embedding the future



### Why Choose DSL?

- ✓ Lifetime technical support
- ✓ Fully customisable products
- ✓ Product branding (bezel colours + company logos)
- ✓ Free pre-installation of OS and your software



### Our Services

- ✓ Electronic Design
- ✓ Production Management
- ✓ Assembly and test
- ✓ Bespoke BIOS creation



[sales@dsl-ltd.co.uk](mailto:sales@dsl-ltd.co.uk)

or call us on +44 (0)1462 675530





# ADP-1120/ADP-1150/ADP-1170/ADP-1190 Display Monitor User Manual

<u>Release Date</u>	<u>Revision</u>
April 2005	V0.1
May 2007	V0.2
Aug. 2007	V0.3

©2005 Aplex Technology, Inc.

All Rights Reserved.

Published in Taiwan

Aplex Technology, Inc.

9F-5, No. 2, Jian Pa Road, Chung Ho City, Taipei County, Taiwan

Tel: 886-2-82262881 Fax: 886-2-82262883 E-mail: [aplex@aplex.com.tw](mailto:aplex@aplex.com.tw) URL: [www.aplex.com.tw](http://www.aplex.com.tw)

# Warning!

---

This equipment generates, uses and can radiate radio frequency energy and if not installed and Used in accordance with the instructions manual may cause interference to radio communications. It has been tested and found to comply with the limits for a Class A computing device pursuant to FCC Rules, which are designed to provide reasonable protection against such interference when Operated in a commercial environment. Operation of this equipment in a residential area is likely To cause interference in which case the user at his own expense will be required to take whatever Measures may be required to correct the interference

Electric Shock Hazard – Do not operate the workstation with its back cover removed. There are dangerous high voltages inside.

## Disclaimer

**This information in this document is subject to change without notice. In no event shall Apex Technology Inc. be liable for damages of any kind, whether incidental or consequential, arising from either the use or misuse of information in this document or in any related materials.**

# Table of Contents

---

Warning!.....	2
Disclaimer.....	2

## Chapter 1

## Getting Started

1.1 Features.....	4
1.2 Specifications.....	4
1.3 Dimensions.....	6
1.4 Brief Description.....	10
1.5 Display Mode.....	11

## Chapter 2

## OSD

2.1 Front Panel Controls.....	12
2.2 OSD Controls.....	12
2.3 Main Menu.....	13
2.4 AD Board (TB-6020) OSD Functions.....	15

## Figures

---

Figure 1.1: Dimensions of ADP-1120.....	6
Figure 1.2: Dimensions of ADP-1150.....	7
Figure 1.3: Dimensions of ADP-1170.....	8
Figure 1.4: Dimensions of ADP-1190.....	8
Figure 1.5: Overall View.....	10
Figure 1.6: Rear View.....	10

## Appendix

---

Panelmounting.....	16
Rackmounting.....	16

# Chapter 1

---

## 1.1 Features

	ADP-1120	ADP-1150	ADP-1170	ADP-1190
Display	12.1" TFT SVGA LCD	15" TFT XGA LCD	17" TFT SXGA LCD	19" TFT SXGA LCD
Luminance	300 cd/m <sup>2</sup>	400 cd/m <sup>2</sup>	300 cd/m <sup>2</sup>	250 cd/m <sup>2</sup>
Front panel NEMA 4/IP 65 rating				
Wall-mount screw holes				
Resistive touch screen (optional)				
Optional DVI, Video or S-Video input <sup>o</sup>				
Supports wide-ranging resolutions from 640x480 to up to 1600 x 1200 with auto phase and auto position.				

## 1.2 Specifications

### Display

	ADP-1120	ADP-1150	ADP-1170	ADP-1190
Display	12.1"	15"	17"	19"
Luminance	300 cd/m <sup>2</sup>	400 cd/m <sup>2</sup>	300 cd/m <sup>2</sup>	250 cd/m <sup>2</sup>
Viewing Angle	120(H)x95(V)	140(H)x125(V)	140(H)x130(V)	140(H)x130(V)
Resolution	800x600, 16.2M colors	1024x768, 16.2M colors	1280x1024, 16.2M colors	1280x1024, 16.2M colors
Backlight	CCFL tube x 2, 50,000hrs (1/2 brightness)	CCFL tube x 4 50,000hrs (1/2 brightness)	CCFL tube x 4 50,000hrs (1/2 brightness)	CCFL tube x 4 50,000hrs (1/2 brightness)
Touch Screen	Resistive antiglare	Resistive antiglare	Resistive antiglare	Resistive antiglare
OSD Controls/Indicators	Automatic screen, setup (OSD), brightness, contrast, horizontal/vertical position, image lock, color balance, video information, power on and sync detected			
OS Compatibility	Win 95/98, XP, 2000, NT 4.0, QNX, Linux			
Internal Power Adapter	Input: 100~240 ±10% VAC, auto ranging, output: +12VDC@5A			

## Environment

Operating Temperature: 0~50°C (32°~122°F)
Storage Temperature: -20~60°C (-4°~140°F)
Relative Humidity: 10~90% @40°C non-condensing, without touch screen
Vibration: 1g peak, 5~500Hz (at random)
Shock: 15G peak acceleration (11msec. duration)/operation
Ratings: NEMA 4/12, IP65
Certifications: CE/FCC Class A

## Mechanical

	ADP-1120	ADP-1150	ADP-1170	ADP-1190
Construction	Steel chassis and front panel	Steel chassis and front panel	Steel chassis and front panel	Steel chassis and front panel
Dimensions	390x63x265 (Wx Dx H / mm)	410x69x310mm (Wx Dx H / mm)	457x75x355 (Wx Dx H / mm)	484x71.7x400 (Wx Dx H / mm)
Dimensions Cutout	372(W)x246mm(H)	392(W)x292mm(H)	422(W)x331mm(H)	448(W)x360mm(H)
Weight				
Mounting Options	Panel mount, rack mount (optional)	Panel mount, rack mount (optional)	Panel mount, rack mount (optional)	Panel mount, rack mount (optional)

## Ordering Information

ADP-1120	12.1" industrial display monitor (steel bezel)
ADP-1120T	12.1" industrial display monitor (steel bezel) with resistive touch screen
ADP-1150	15" industrial display monitor (steel bezel),
ADP-1150T	15" industrial display monitor (steel bezel) with resistive touch screen
ADP-1170	17" industrial display monitor (steel bezel)
ADP-1170T	17" industrial display monitor (steel bezel) with resistive touch screen
ADP-1190	19" industrial display monitor (steel bezel)
ADP-1190T	19" industrial display monitor (steel bezel) with resistive touch screen

# 1.3 Dimensions

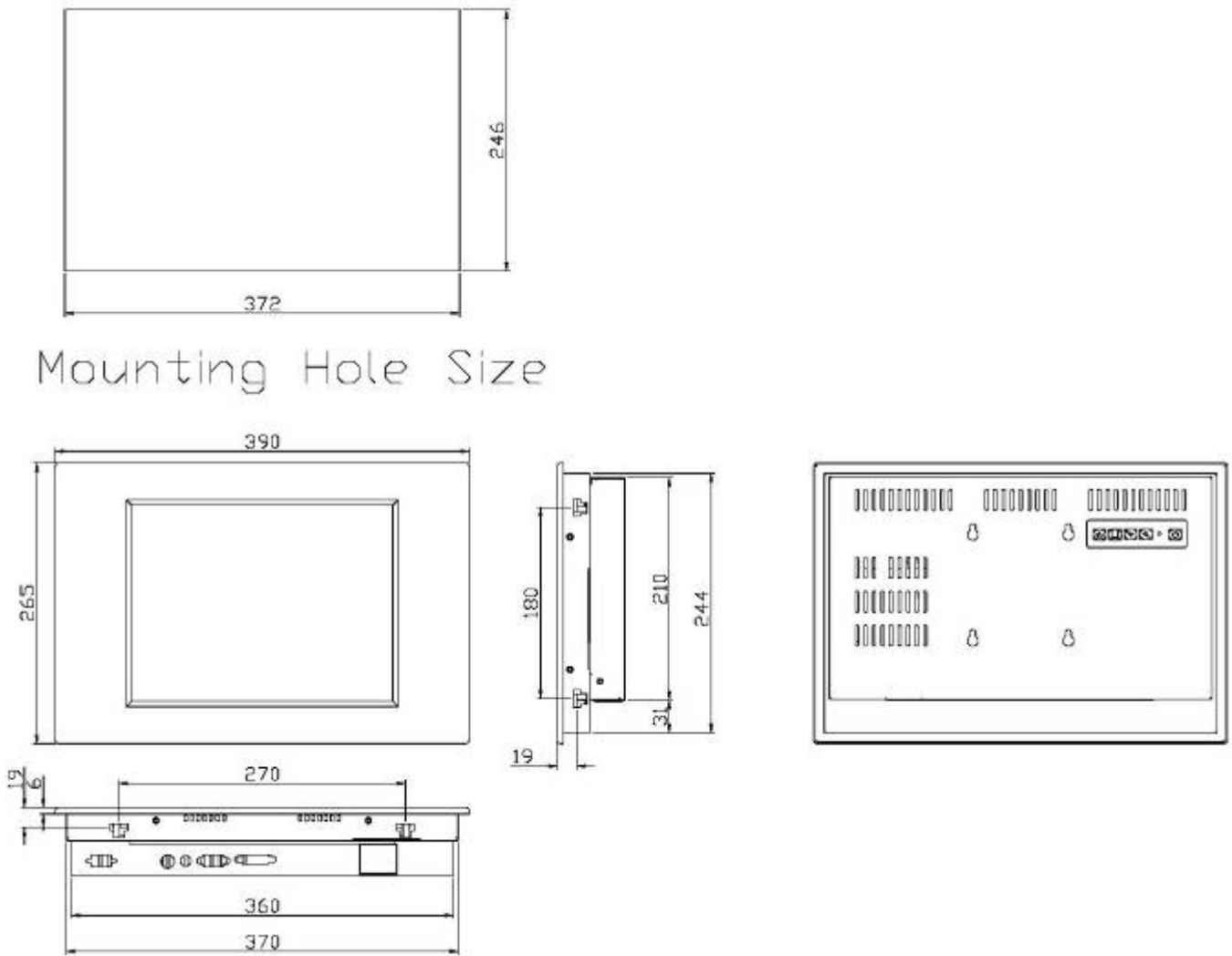

**Figure 1.1: Dimensions of the ADP-1120**

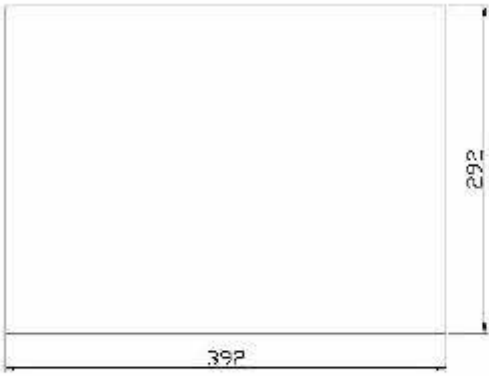

## Mounting Hole Size

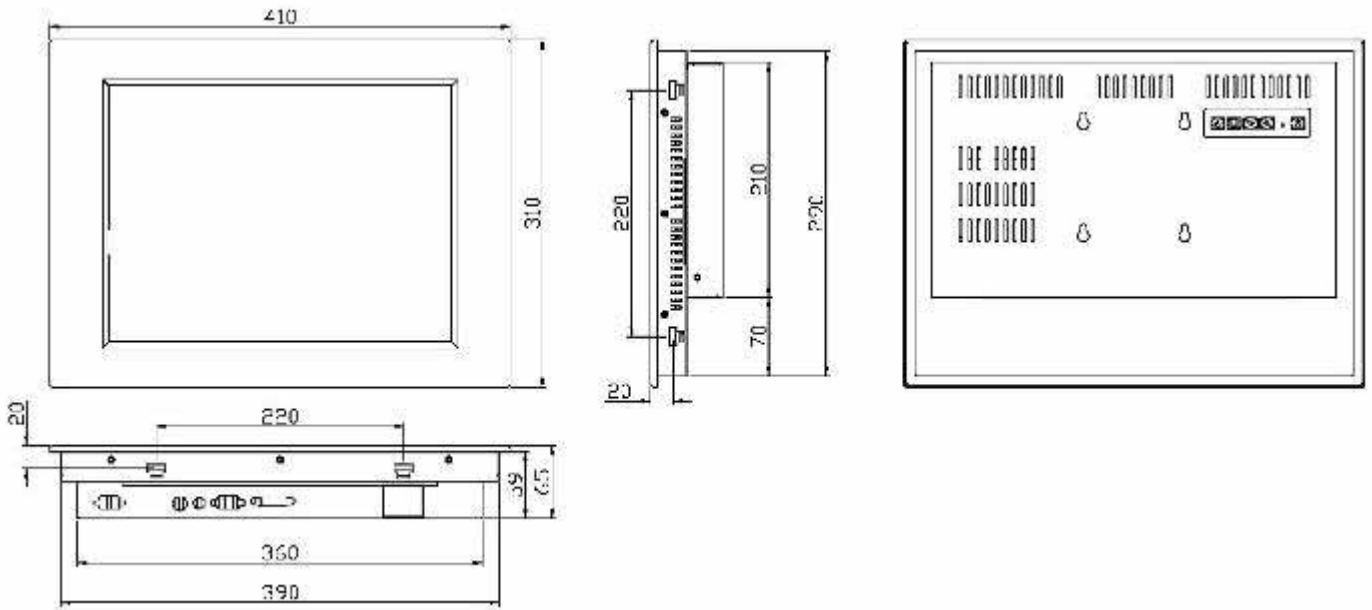
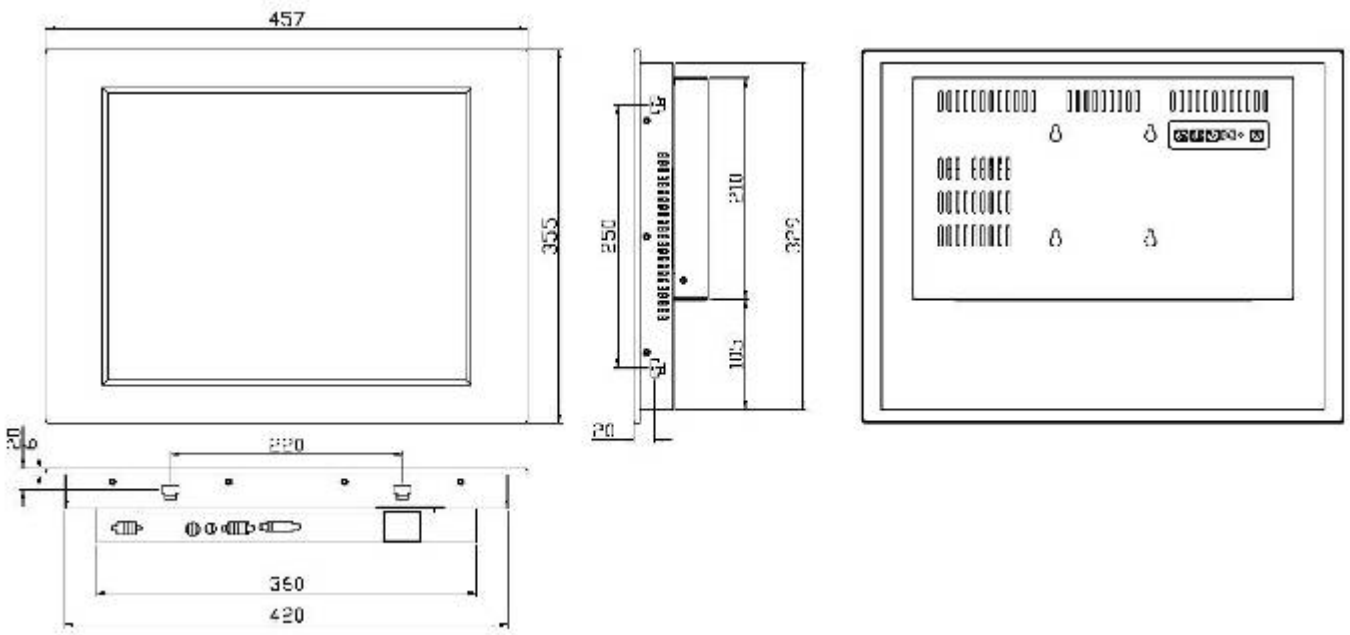

**Figure 1.2: Dimensions of the ADP-1150**





Mounting Hole Size



**Figure 1.3: Dimensions of the ADP-1170**

# ADP-1190\_ASM

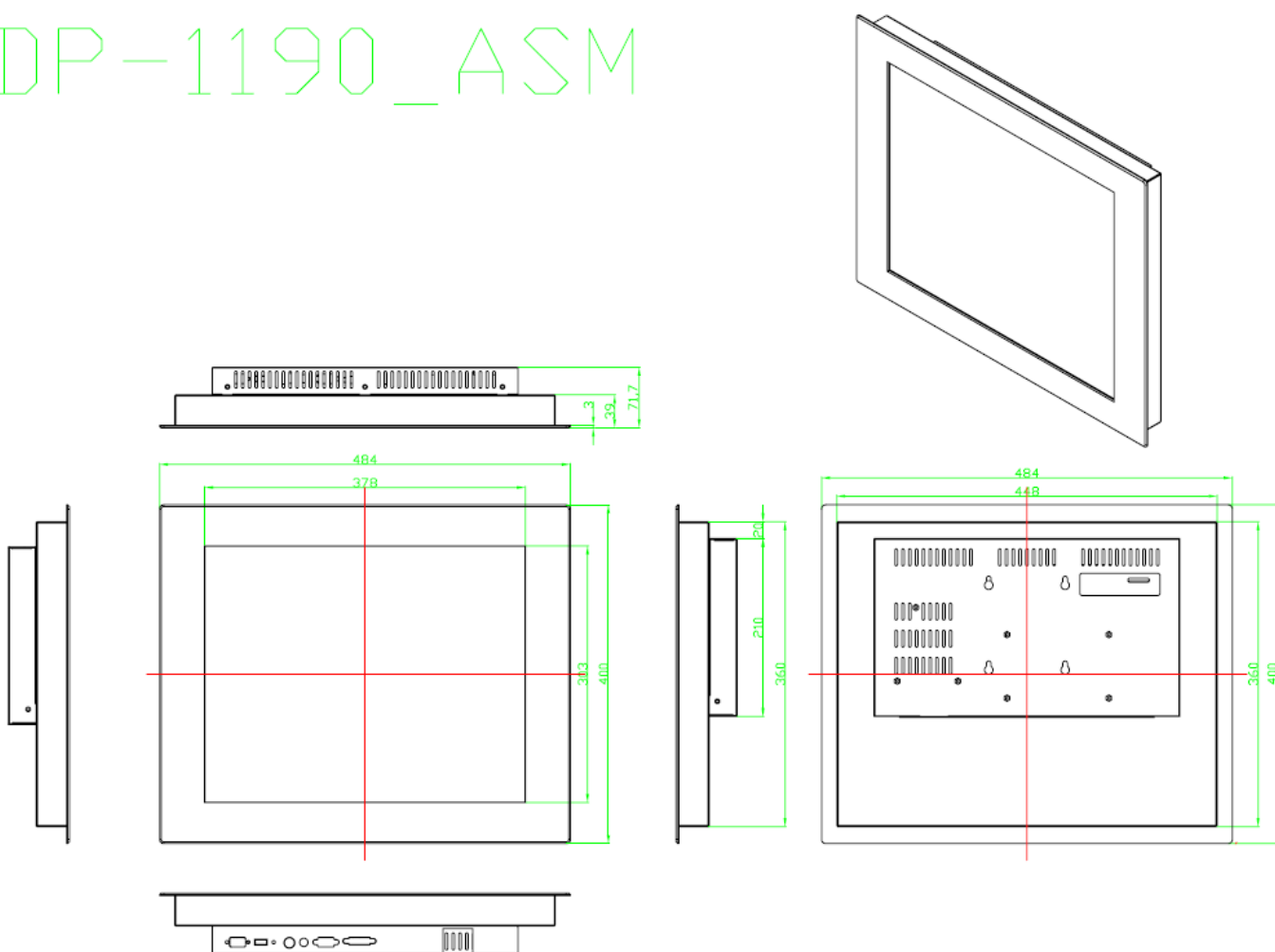

**Figure 1.4: Dimensions of the ADP-1190**

## 1.4 Brief Description of the ADP-1120, ADP-1150, ADP-1170 & 1190

The ADP-1120, the ADP-1150, the ADP-1170 and the ADP-1190 feature an excellent viewing ability for monitoring and control applications. It is available with resistive touch screen that is easy to use and maintain.

The front panel of the display monitor is sealed with gasket for NEMA 4/IP 65 rating when it is panel-mounted in a NEMA rated cabinet or enclosure.



**Figure 1.4: Overall View of  
ADP-1120 (12.1”), ADP-1150 (15”), ADP-1170 (17”) & ADP-1190(19”)**



**Figure 1.5: Rear View of  
ADP-1120 (12.1”), ADP-1150 (15”) & ADP-1170 (17”), & ADP-1190(19”)**

## 1.5 Display Mode

Display Mode		Hori. Sync (KHz)	Vert. Sync. (Hz)
VGA 640 x 480		31	60
		38	72
		38	75
SVGA 800 x 600		35	56
		38	60
		48	72
		47	75
XGA 1024 x 768		48	60
		56	70
		60	75
SXGA	1152 x 864	68	75
	1280 x 1024	64	60
		80	75

# Chapter 2

---

## 2.1 Front Panel Controls

 Power switch: To turn ON or OFF the power

 Shift the icon to the right side or shift it up









 Shift the icon to the left side or shift it down

 Menu: To enter OSD menu for related icon and item.

 Auto Button: One-touch auto adjustment

## 2.2 OSD Controls

To make any adjustment, select the following:

1. Press  (Menu) to show the OSD menu or disable the OSD menu.
2. Select the icon that you wish to adjust with the (/ or +/-) key in the menu.
3. Press  (Menu) and then choose the item with the (/ or +/-) key.
4. Press  (Menu) and then adjust the quality with the (/ or +/-) key.

## 2.3 Main Menu

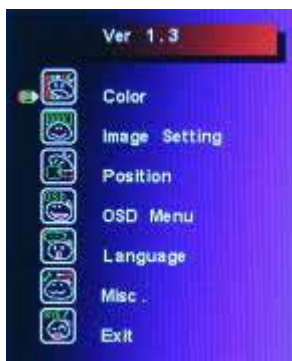

In the **Main** menu, there are the following items:

- Color
- Image Setting
- Position
- OSD Menu
- Language
- Misc
- Exit



For **Color**, check out the following:

- Contrast
- Brightness
- Color Adjust
- Color Temp
- Back



For **Image setting**, check out the following:

- Clock
- Phase
- Gamma
- Sharpness
- Back



In the **Position**, there are the following:

- H. Position
- V. Position
- Back



In the **OSD** menu, there are:

- OSD H. Pos.
- OSD V. Pos.
- OSD Timer
- Back



In the **Language** menu, there are:

- English
- Frances
- Germany
- Spanish
- Traditional Chinese
- Simplified Chinese
- Japanese





In the **Misc** menu, there are:



- Signal Source
  - Select VGA: Analogue VGA Input
  - Select DVI: Digital DVI-D Input
  - Select AV: Composite Video Input
  - Select SV: S-Video Video Input
- Reset
- Back

## 2.4 AD Board (TB-6020) OSD Functions





### 1.) Getting into Burn-in Mode

Before setting into a burn-in mode, first disconnect the AC power cord. Then press (don't let them go) the   buttons until the AC power cord is connected and the “RGB” appears on the top left corner of your screen. Now it can be put into the burn-in mode for changing colors.

### 2.) Getting Out of Burn-in Mode

Before getting out of the burn-in mode, please first disconnect the AC power cord. Then press the  button (If not workable, press the  button and don't let them go) until the AC power cord is connected. Please don't let your fingers go until the AC power cord is connected again and the wording of “RGB” appears on the top left corner of your screen, and wait for 3 second. Under the non-signal entry situation, if **Cable Not Connected** is seen, exit is thus successfully made.

### When the Burn-in Mode is Unable to Eradicate...

- 1.) If the “RGB” is still on the top left corner of the screen, press  to enter “Miscellaneous” and choose “Reset”, and then **Yes**, and press . When the screen goes black, disconnect power and repeat the above steps.
- 2.) If the “RGB” is not found, disconnect the AC power cord first. Then press the   buttons (don't let them go) until the AC power cord is connected, and wait for 2 to 3 seconds. When “RGB” appears, repeat the above steps.
- 3.) Functions of OSD Keys

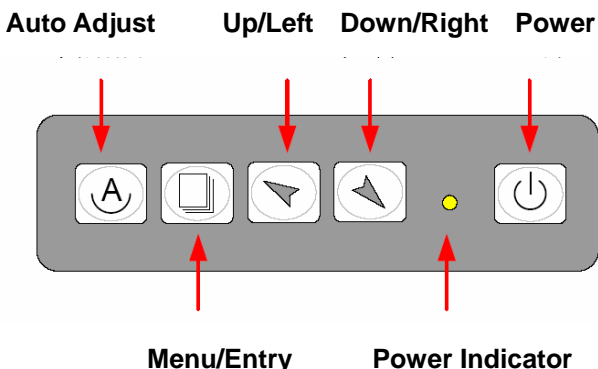



# Appendix

---

## Panel Mounting

The ADP-1120/1150/1170/1190 display monitor is designed to be panel-mounted as shown in Figure A. Just carefully place the unit through the hole and tighten the given 8 screws from the rear to secure the mounting.

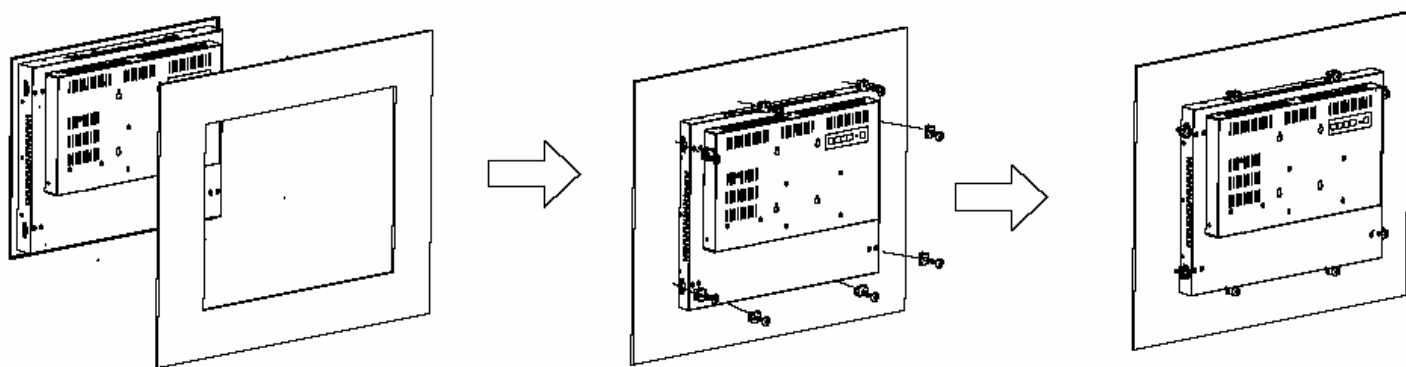

**Figure A: Panelmounting of the ADP1120/1150/1170/1190**

## Rack Mounting (optional)

The ADP-1120/1150/1170/1190 display monitor can be rack-mounted as an option. Just carefully slide it into the rack and tighten the given 8 screws from the front to secure the mounting as shown in Figure B.

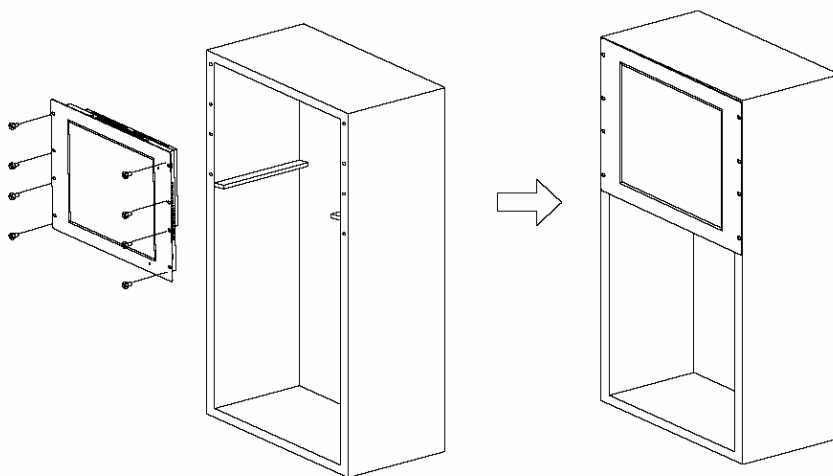

**Figure B: Rackmounting of the ADP1120/1150/1170/1190**